



Introduction: Scattering & Formalisms

How To measure Polarized Light: Instruments

Observations

Some nice Images..



Photometry, Spectroscopy,
Interferometry...

Why Polarimetry?

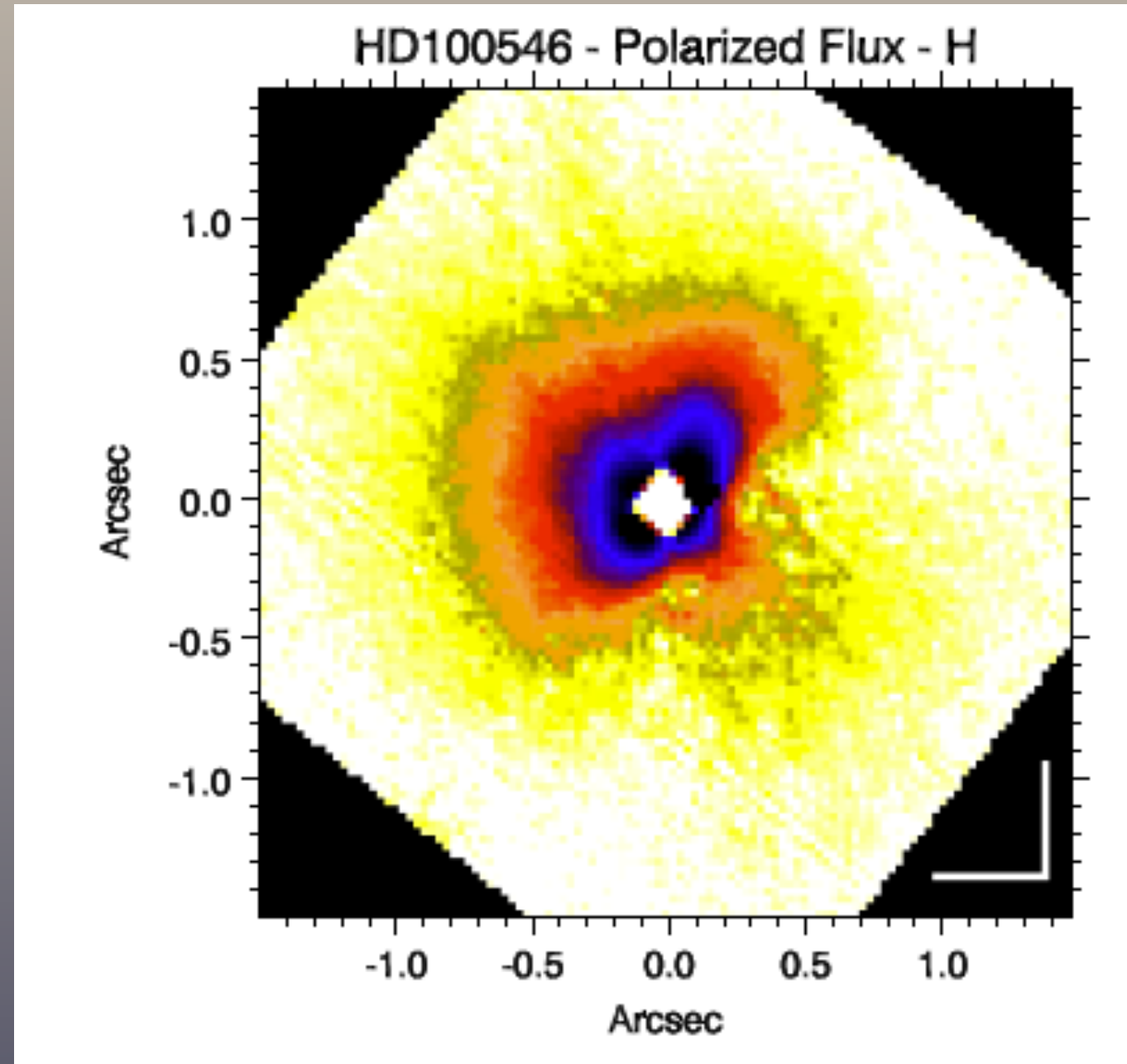



Imaging Polarimetry: Introduction

REMOVE

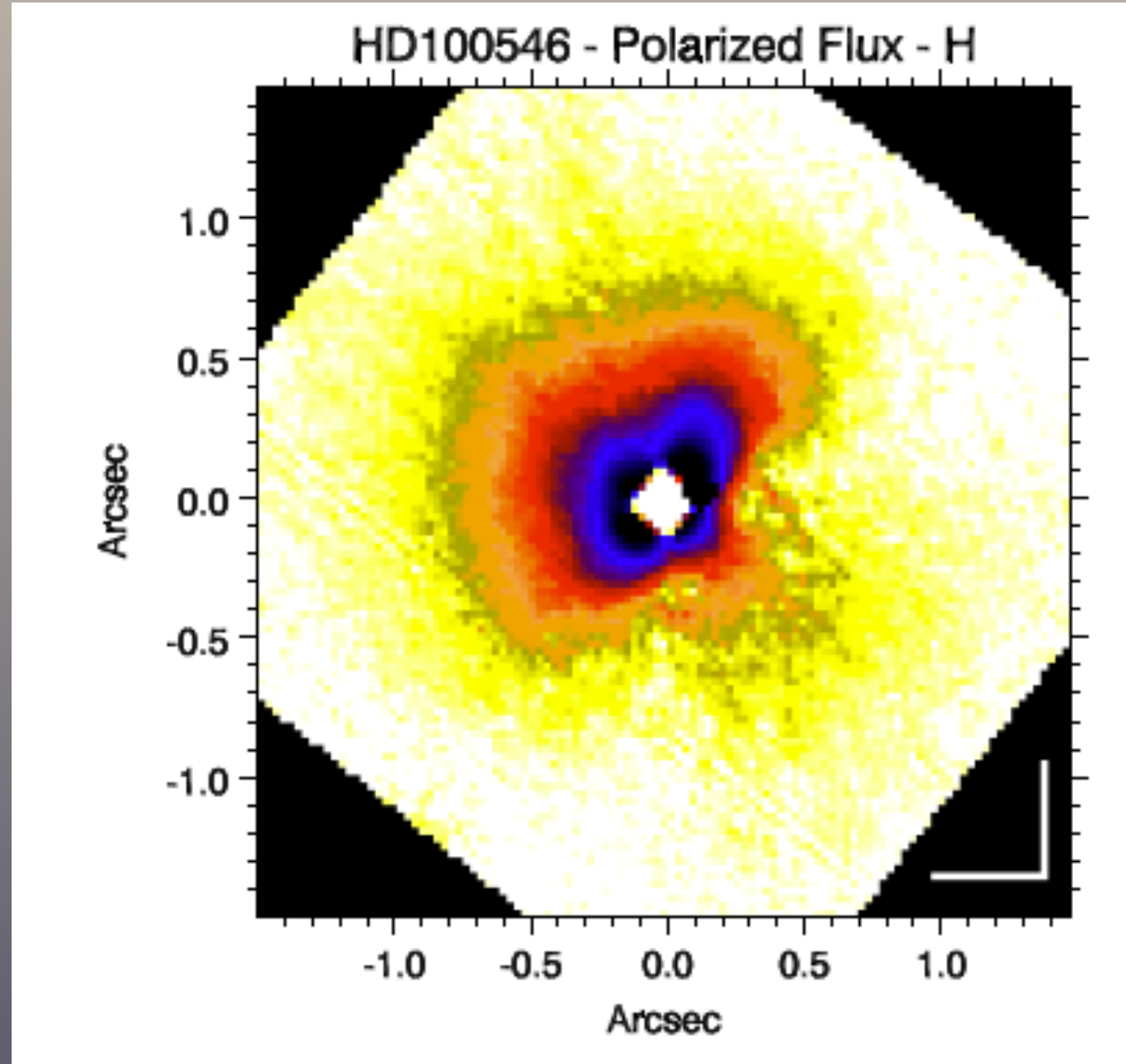



Imaging Polarimetry: Introduction

REMOVE

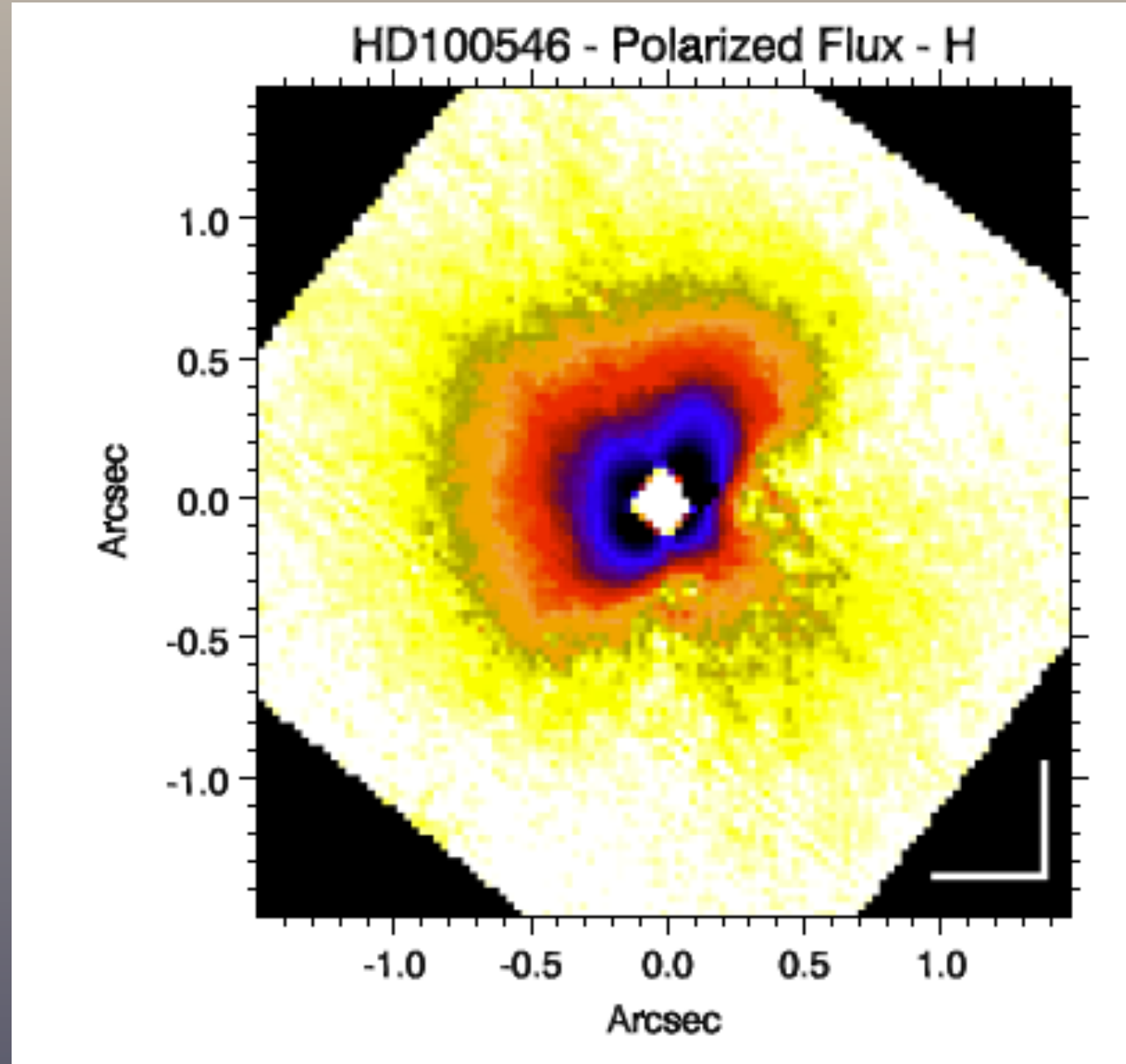

STARLIGHT



Imaging Polarimetry: Introduction

REMOVE

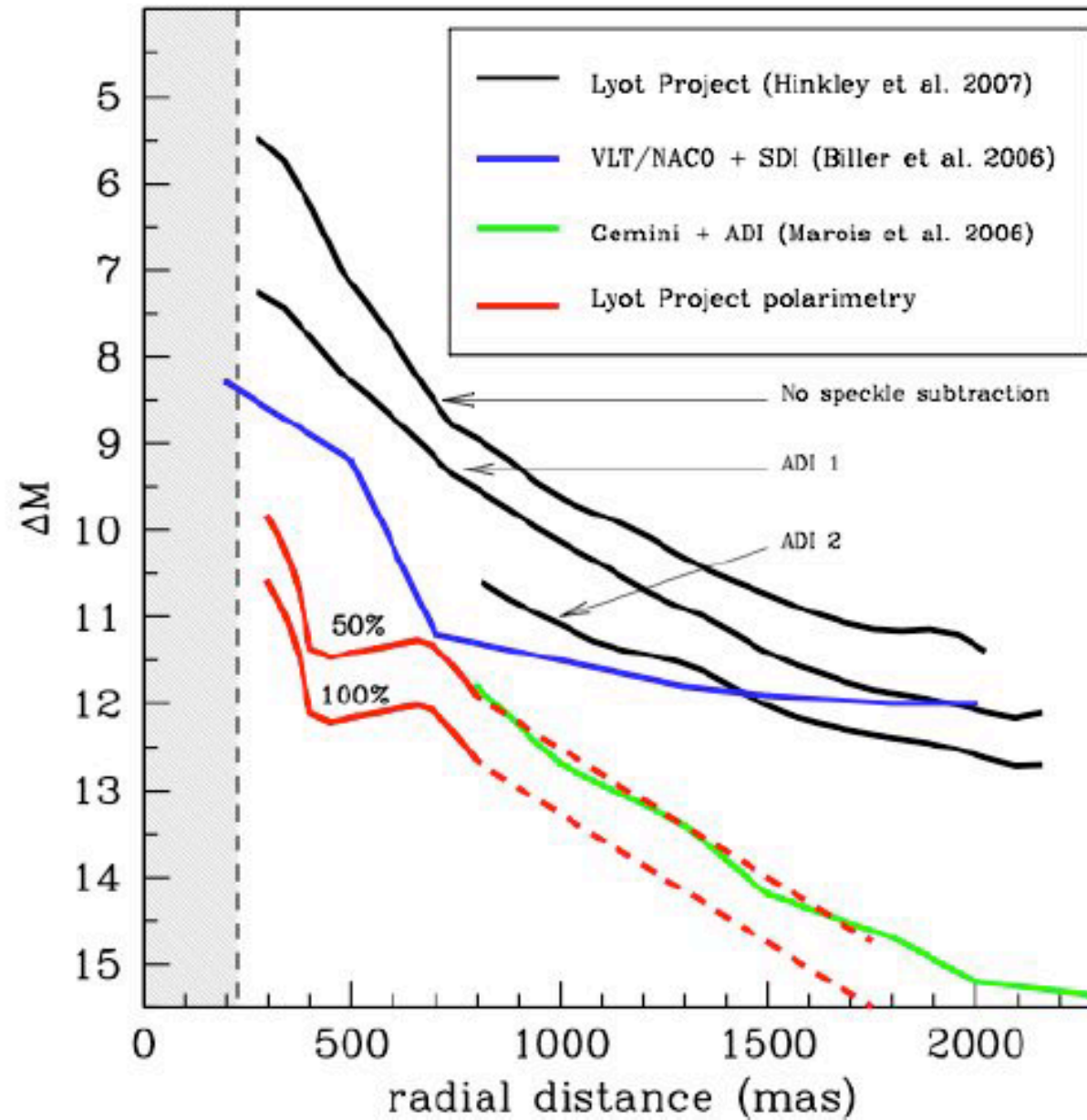

STARLIGHT



Imaging Polarimetry: Introduction

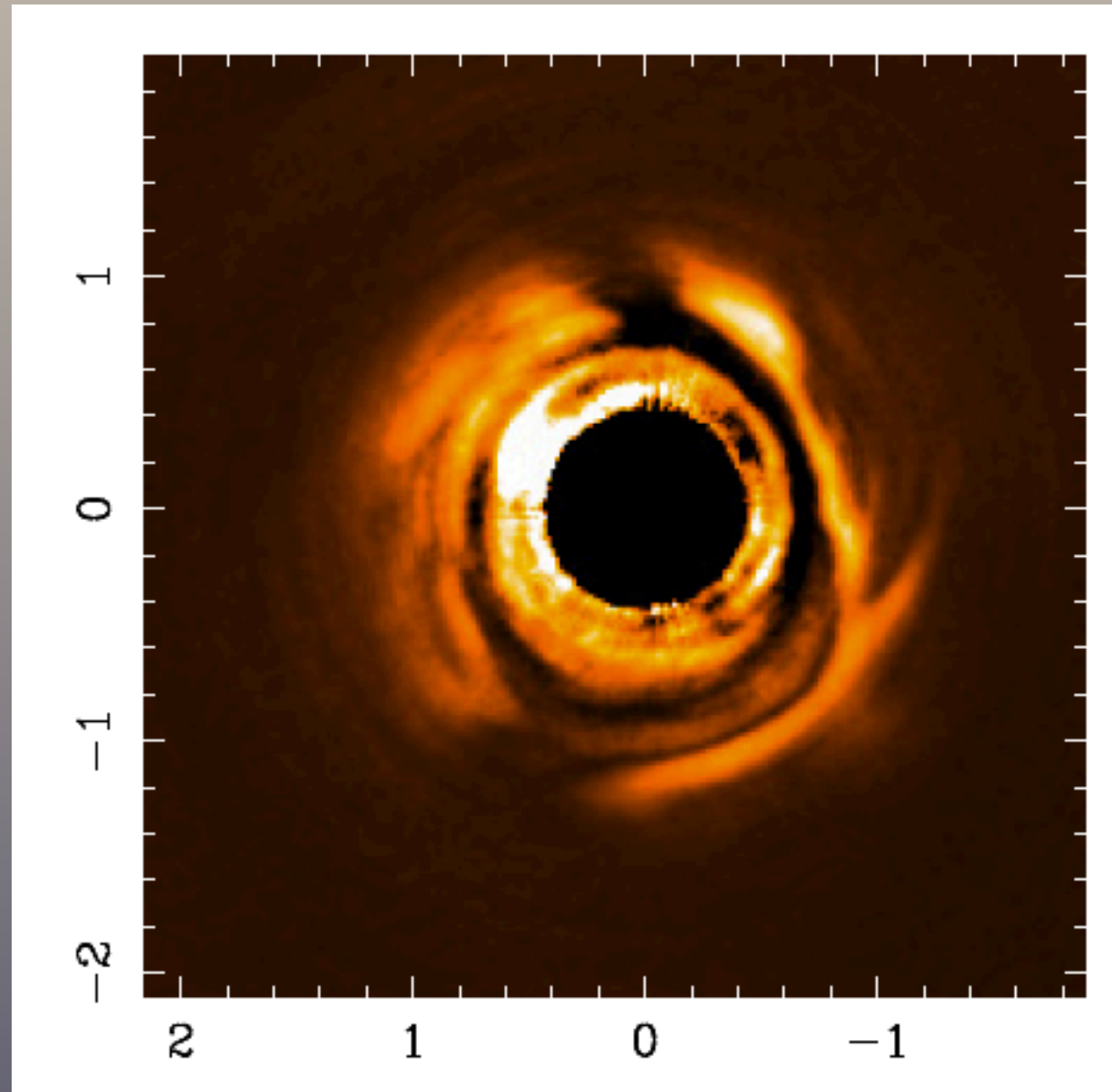



Imaging Polarimetry: Introduction

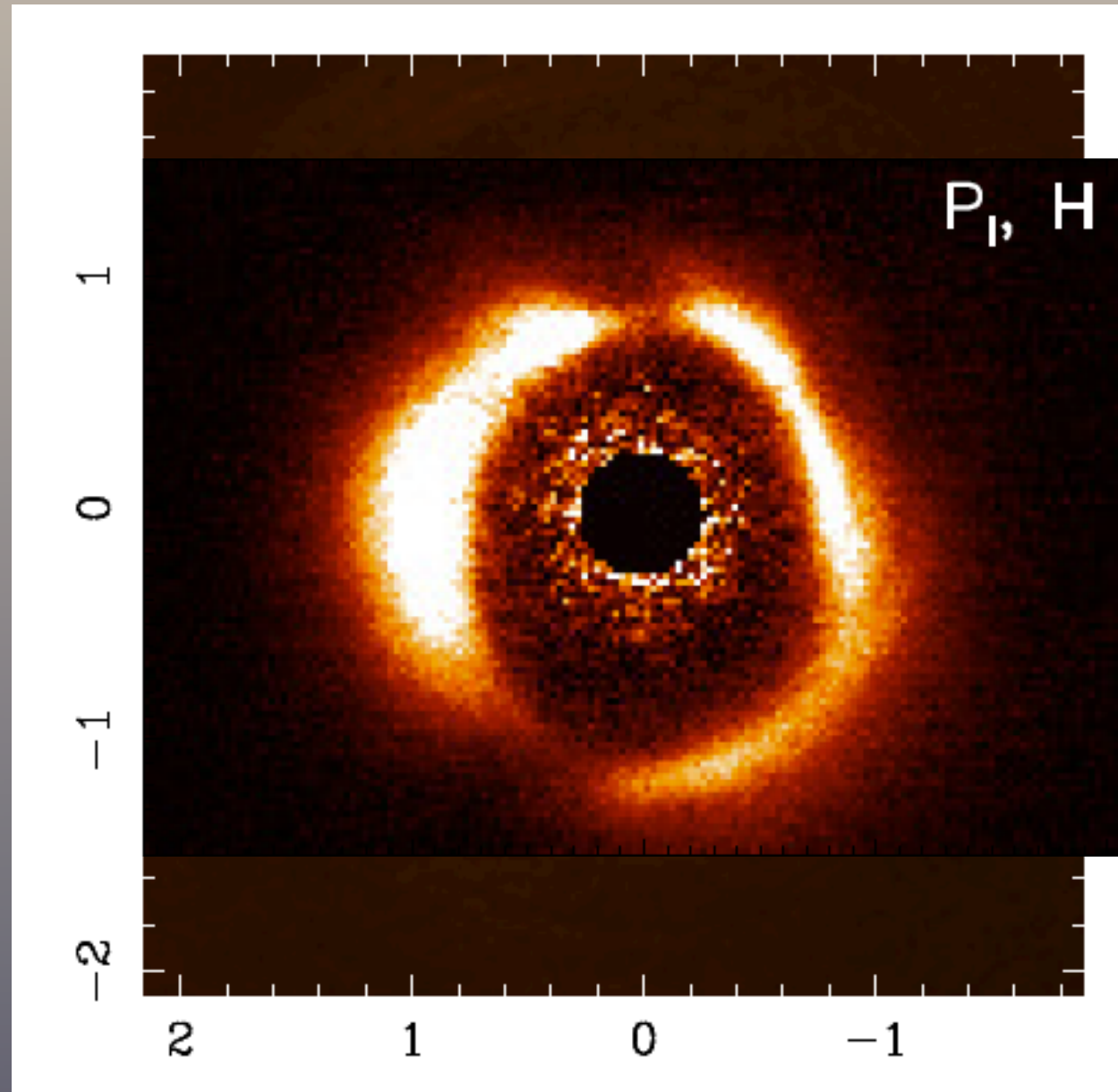



Imaging Polarimetry: Introduction

REMOVE

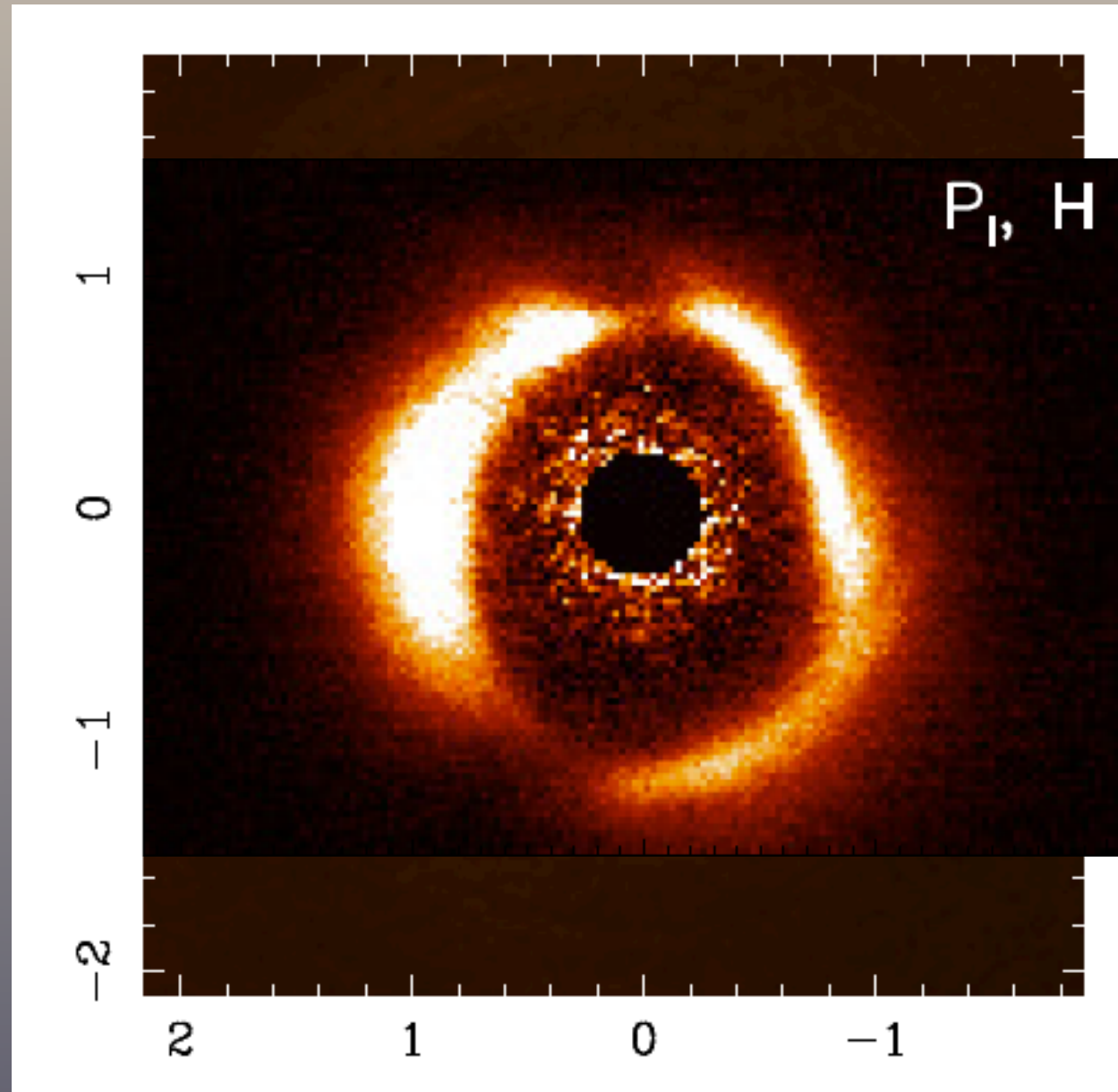



Imaging Polarimetry: Introduction

REMOVE

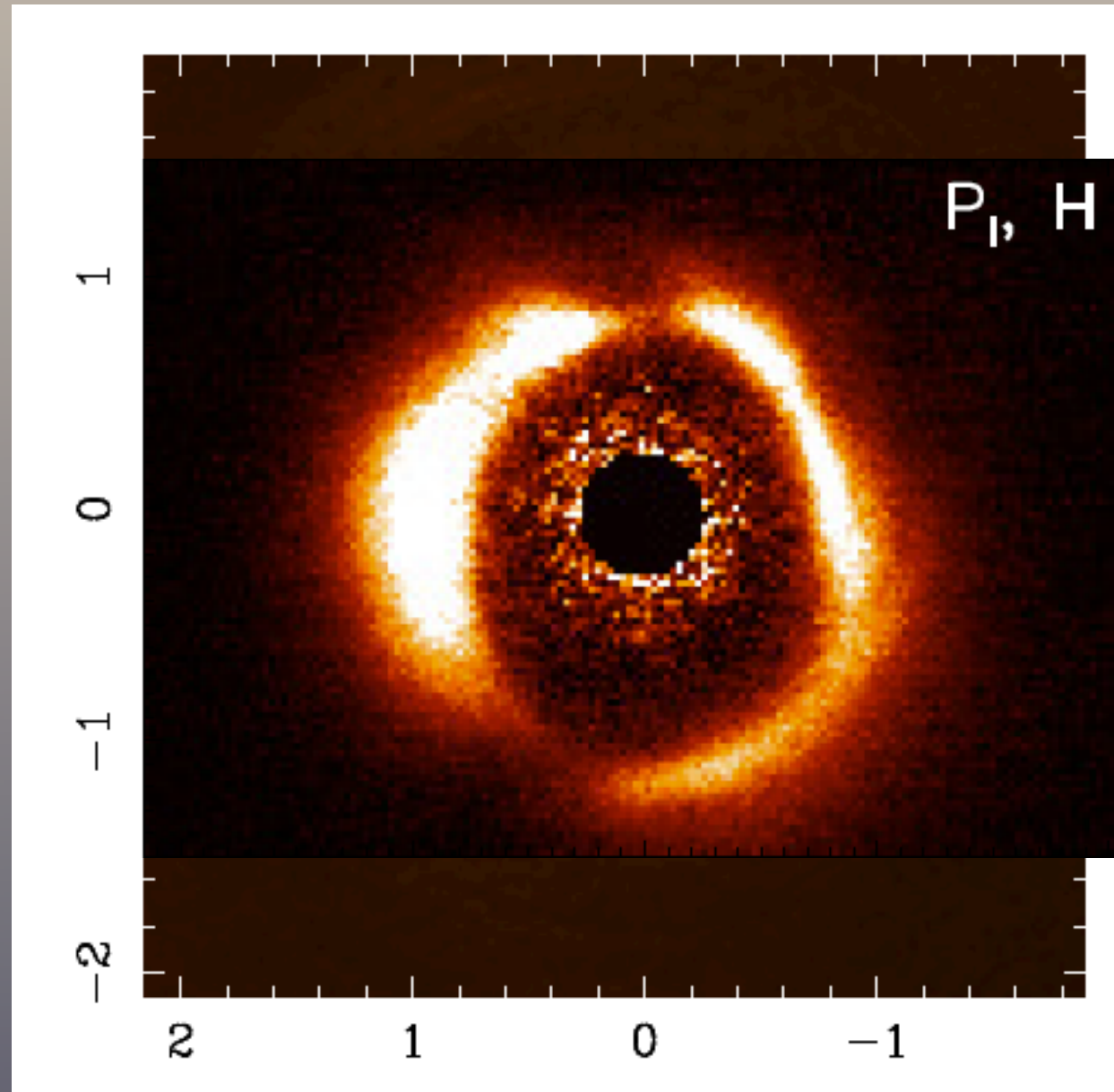

ARTIFACTS



Imaging Polarimetry: Introduction

REMOVE

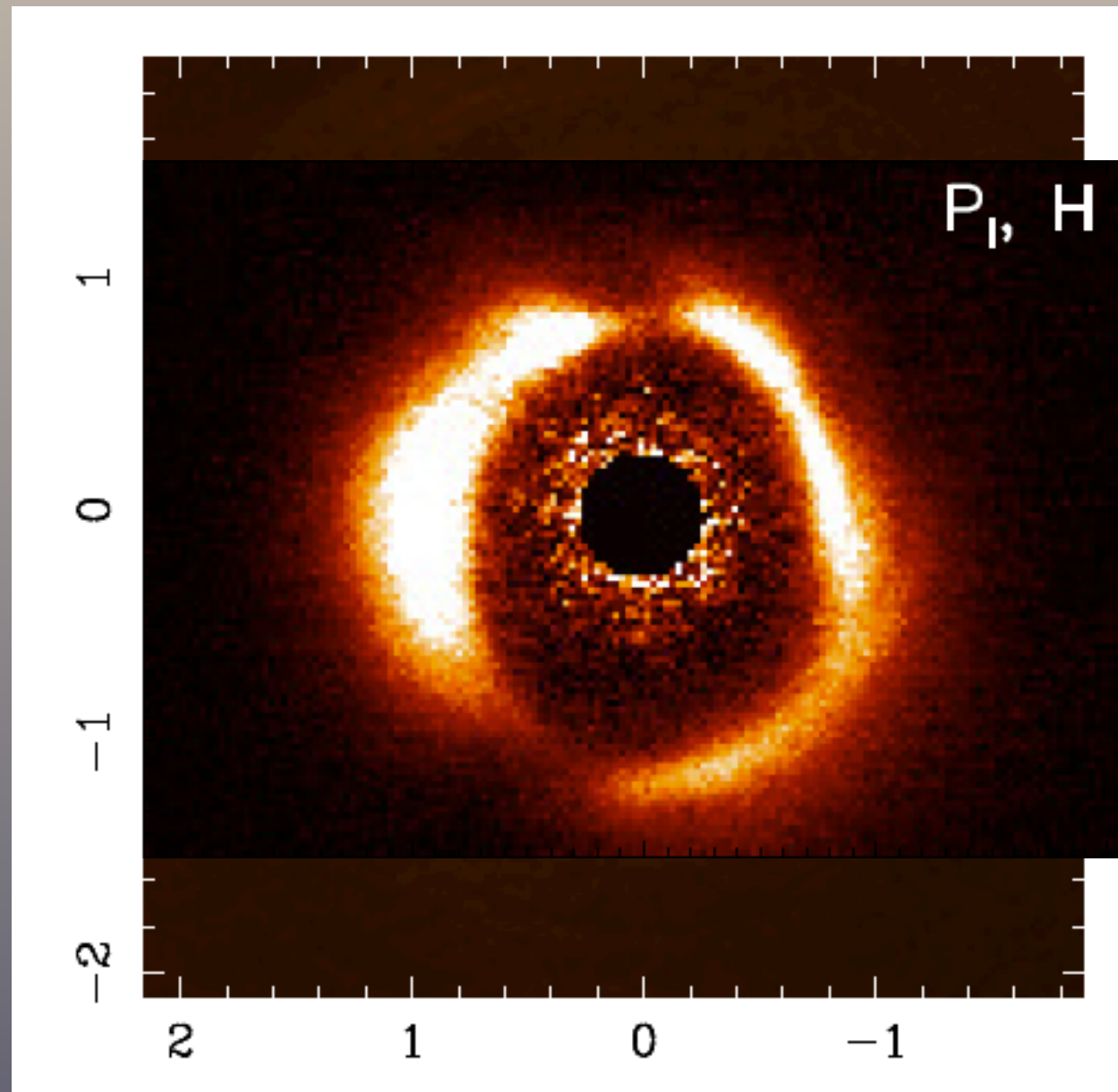

ARTIFACTS



You can combine it!!!

Photometry + Polarimetry = Imaging Polarimetry

Spectroscopy + Polarimetry = SpectroPolarimetry

Interferometry + Polarimetry = Whatever you call it,
but you can also do it

Light Scattering

Polarization of Scattered Sunlight

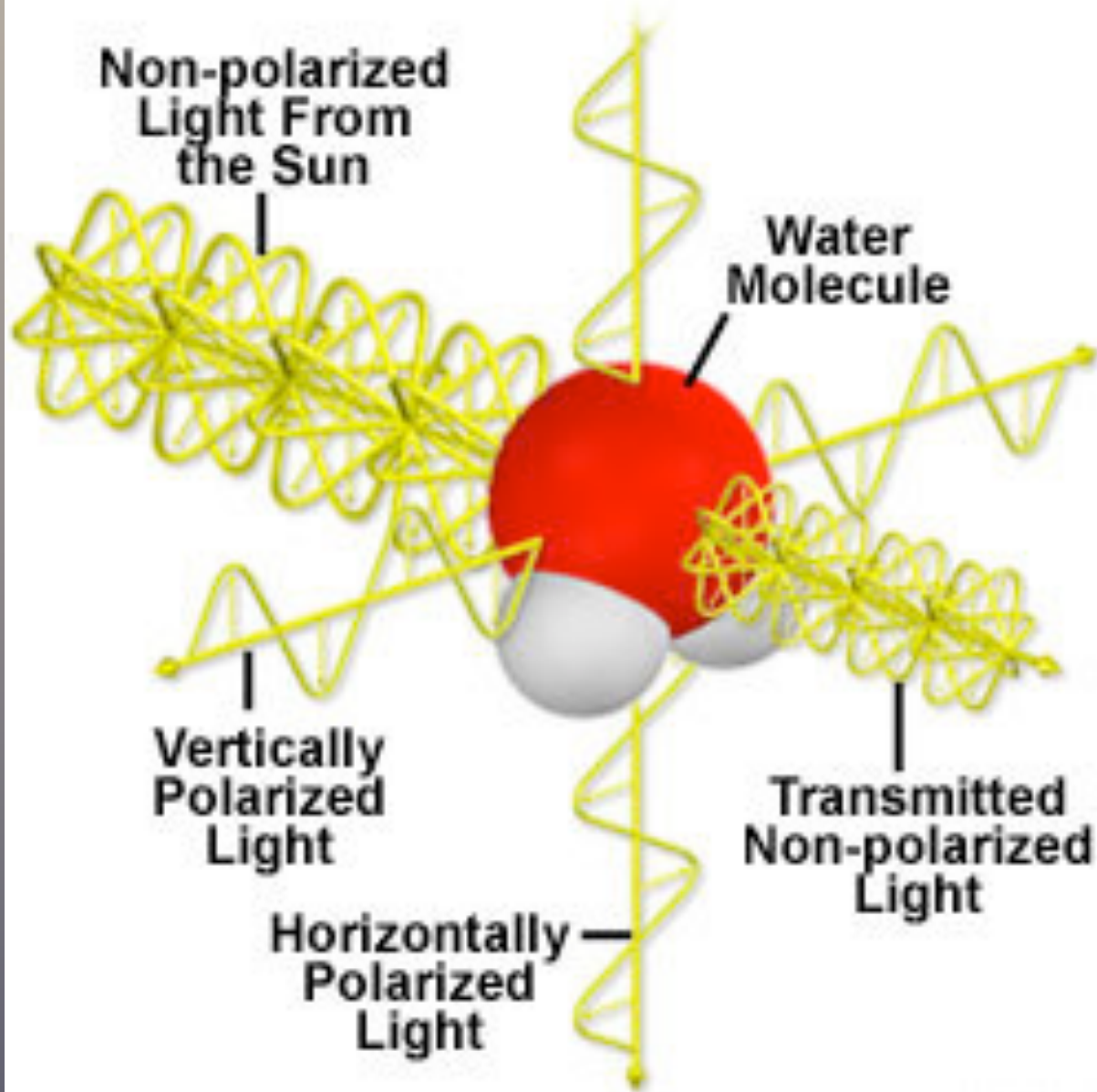

Everything is polarized
(to a certain degree...)

Light Scattering

Polarization of Scattered Sunlight

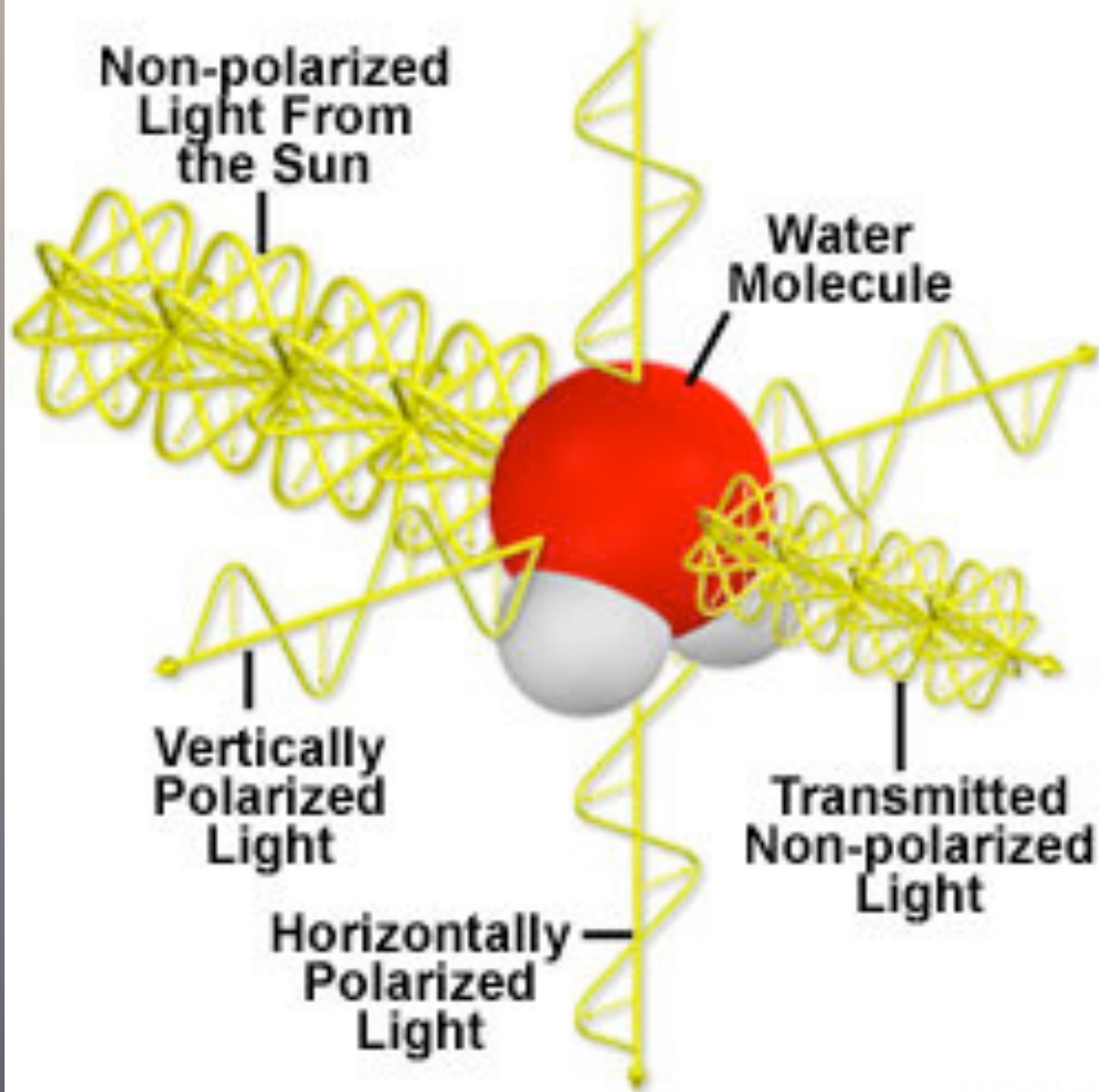

Everything is polarized
(to a certain degree...)

Scattered light
can be
highly polarized

Very basic cartoon...

PLANET...

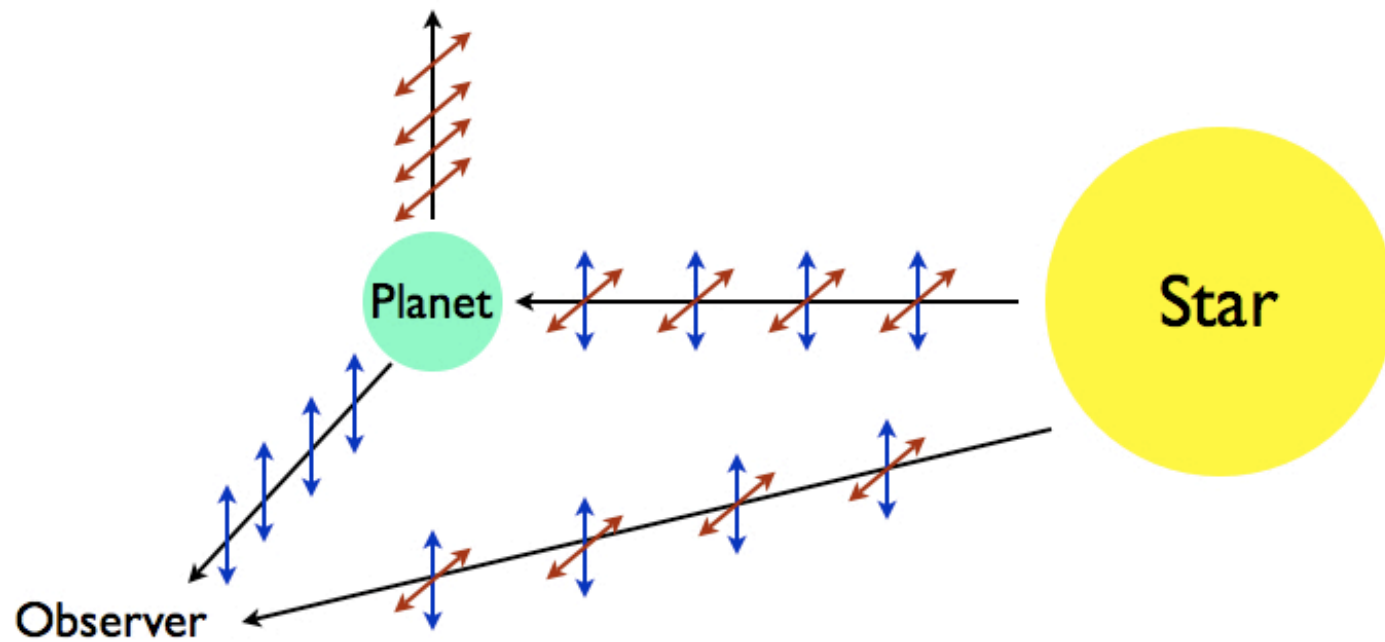

DISK...

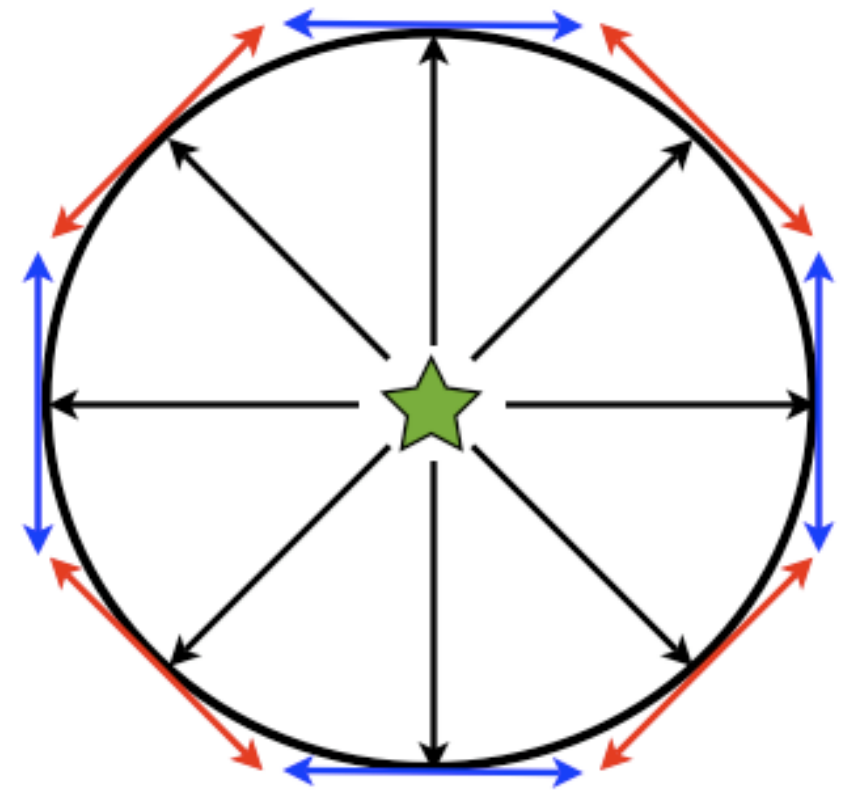



Very basic Equations...

Jones Formalism:
Amplitudes

$$\begin{pmatrix} E_x(t) \\ E_y(t) \end{pmatrix} = E_0 \begin{pmatrix} E_{0x} e^{i(kz - \omega t + \phi_x)} \\ E_{0y} e^{i(kz - \omega t + \phi_y)} \end{pmatrix}$$

Stokes Formalism:
Intensities

$$I = \langle |E_x|^2 + |E_y|^2 \rangle$$

$$Q = \langle |E_x|^2 - |E_y|^2 \rangle$$

$$U = 2 \langle |E_x| |E_y| \cos \phi \rangle$$

$$V = 2 \langle |E_x| |E_y| \sin \phi \rangle$$



The Stokes Parameters = The Holy Grail

100% Q	100% U	100% V
<p>+Q</p> <p>$Q > 0; U = 0; V = 0$</p> <p>(a)</p>	<p>+U</p> <p>$Q = 0; U > 0; V = 0$</p> <p>(c)</p>	<p>+V</p> <p>$Q = 0; U = 0; V > 0$</p> <p>(e)</p>
<p>-Q</p> <p>$Q < 0; U = 0; V = 0$</p> <p>(b)</p>	<p>-U</p> <p>$Q = 0; U < 0; V = 0$</p> <p>(d)</p>	<p>-V</p> <p>$Q = 0; U = 0; V < 0$</p> <p>(f)</p>

Polarization Degree = The Holy Grail (II)

Polarization of Scattered Sunlight

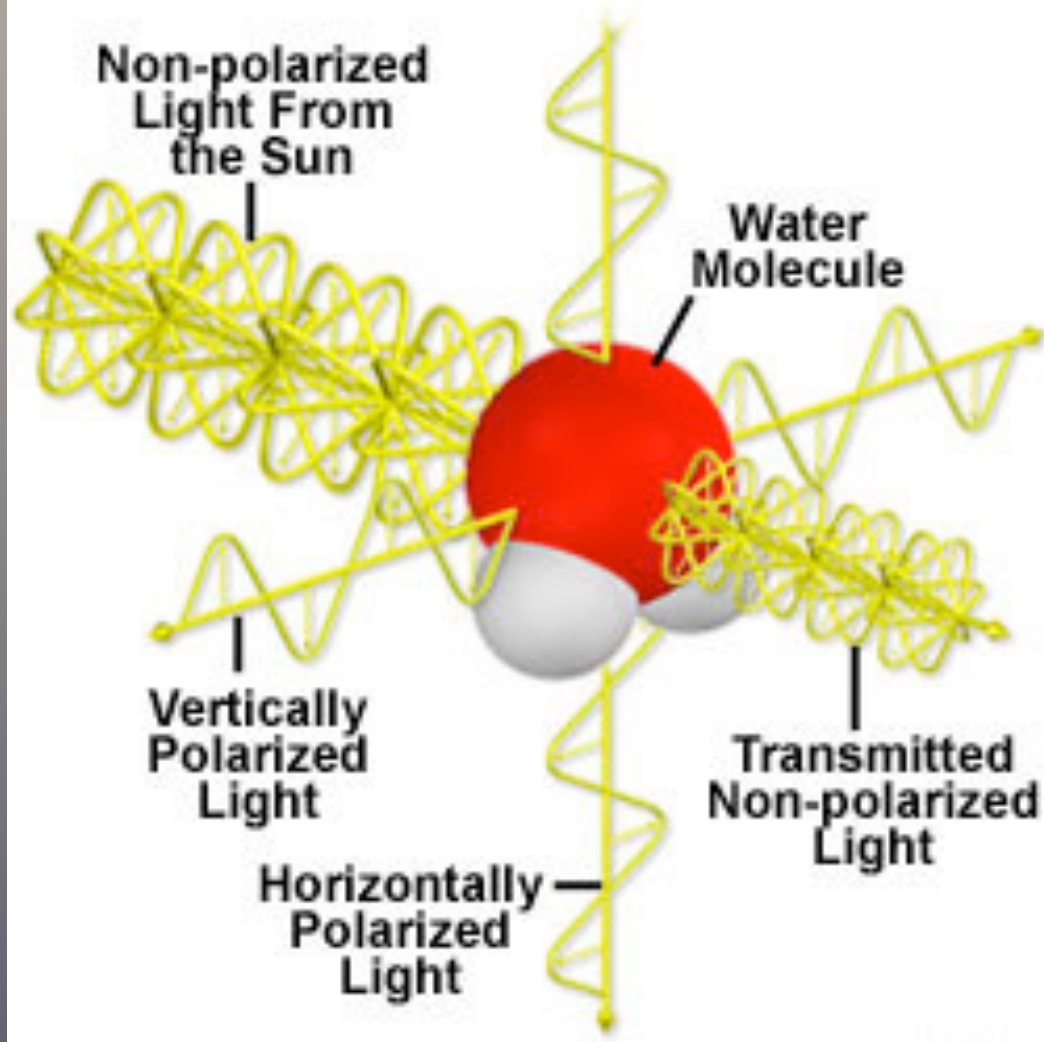

$$P_I = \sqrt{Q^2 + U^2}$$

$$P_{\Theta} = 0.5 \cdot \arctan\left(\frac{U}{Q}\right)$$

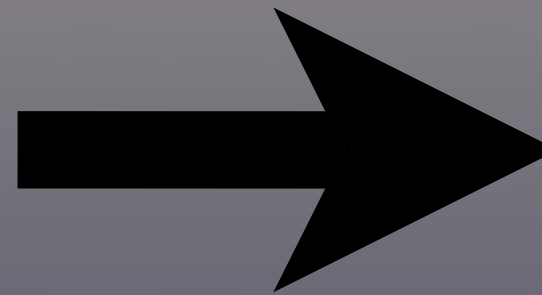

$$P = P_I / I$$

Dust Tracer

Small Grains

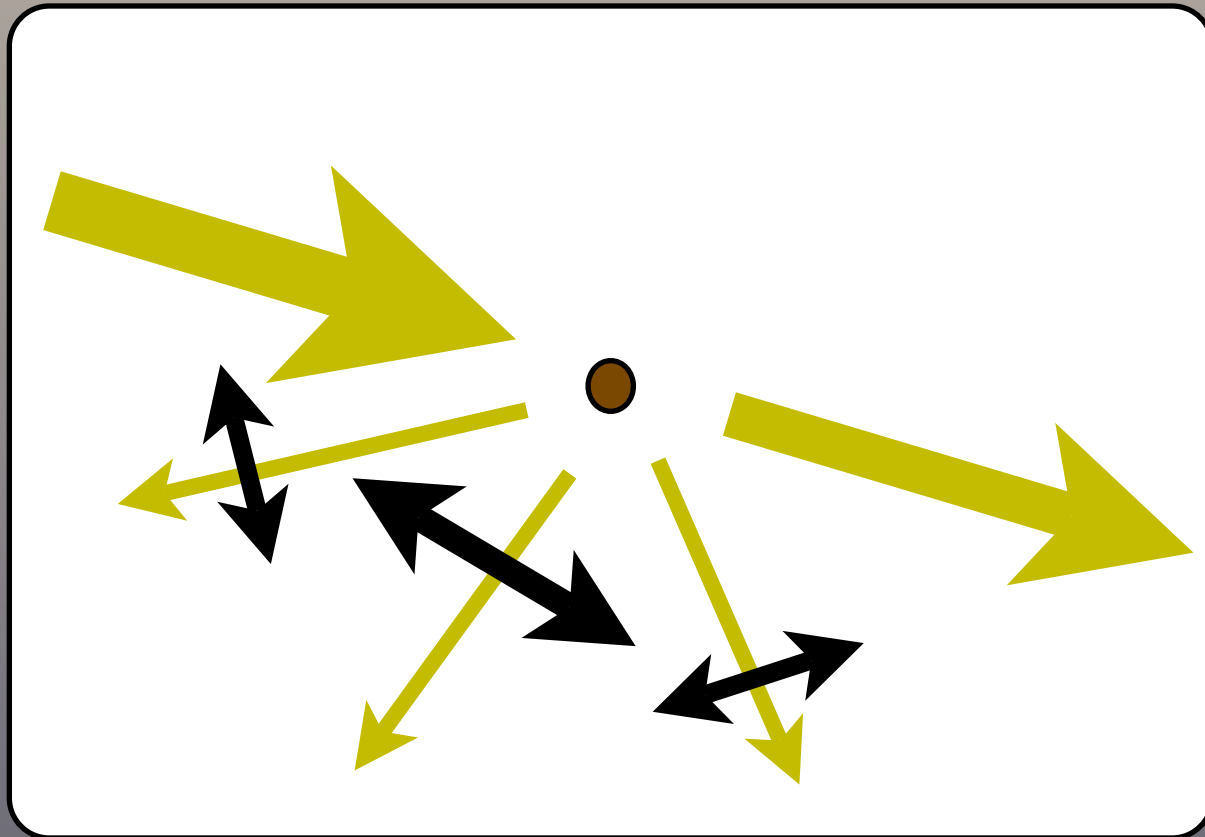

Simmetry

VS

Big Grains

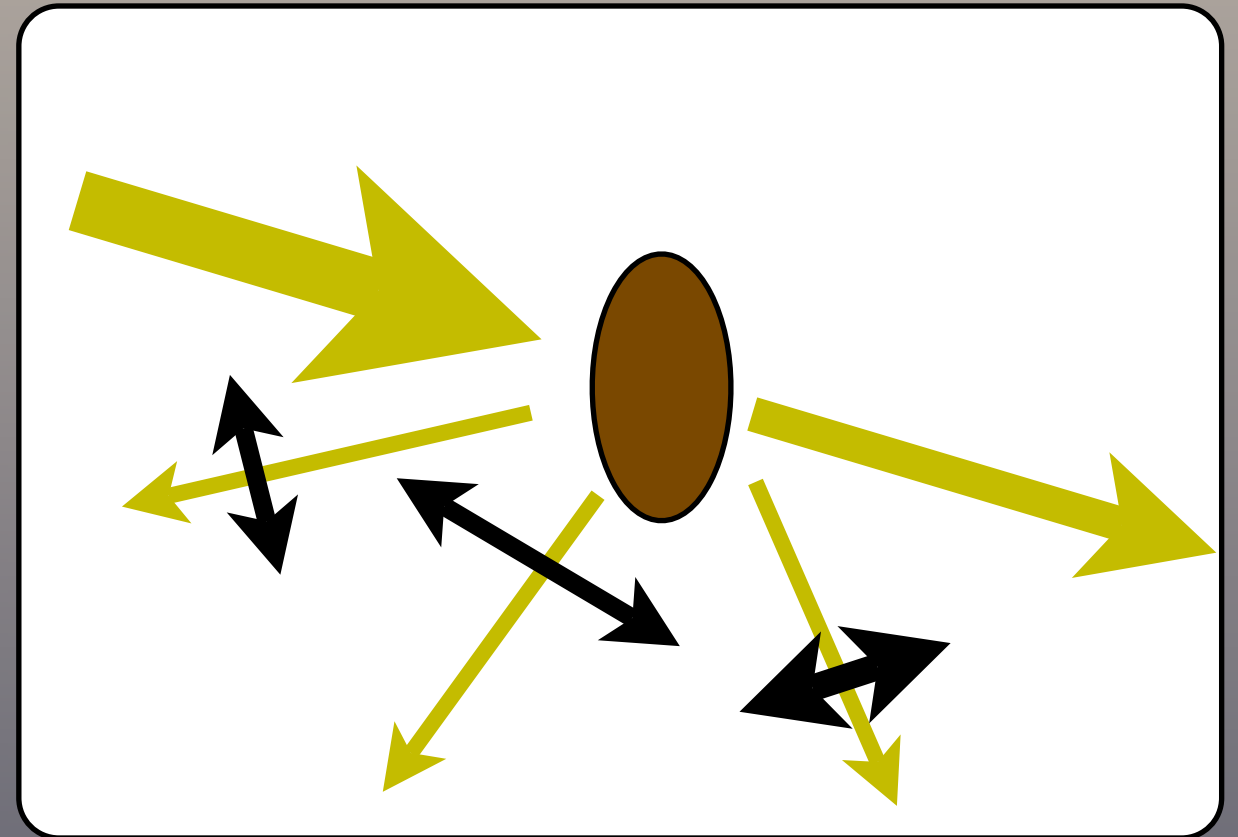

Asimmetry

Geometry Tracer

Understanding Disk Geometry

Flaring (Young??) Disk

Settled (old??) Disk

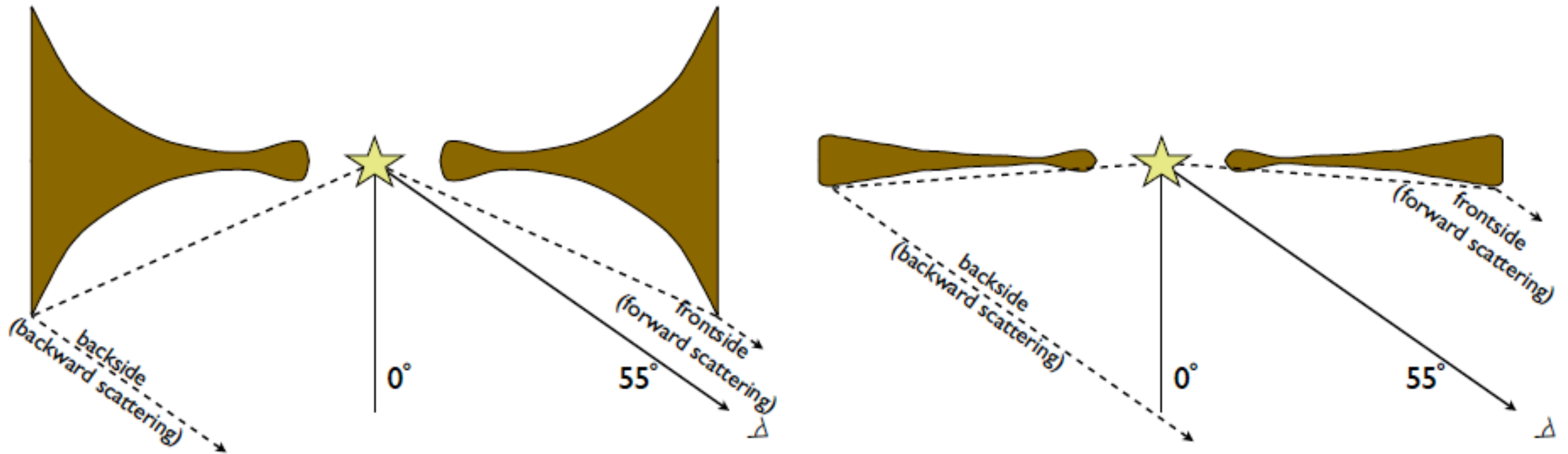



HOW DO WE
MEASURE IT???

Basics...

Half -Wave Plate

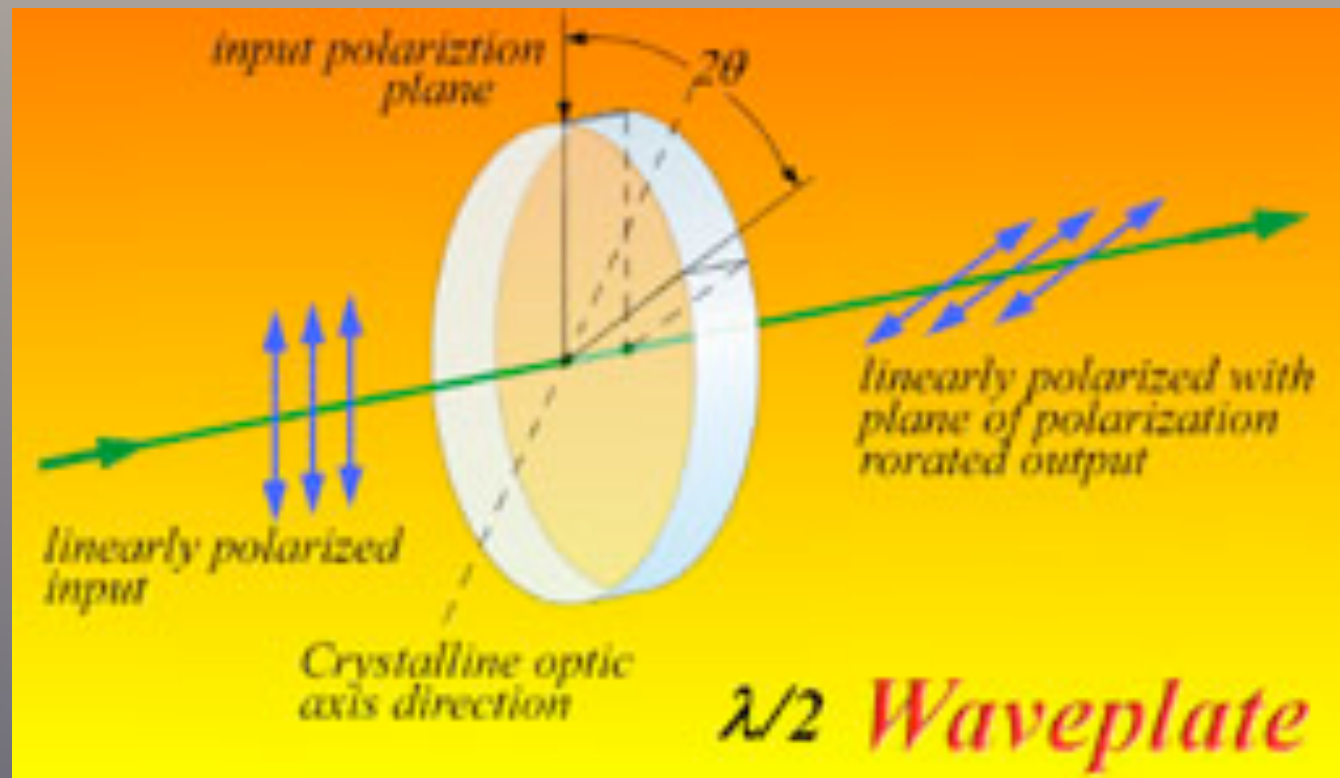

Beamsplitter

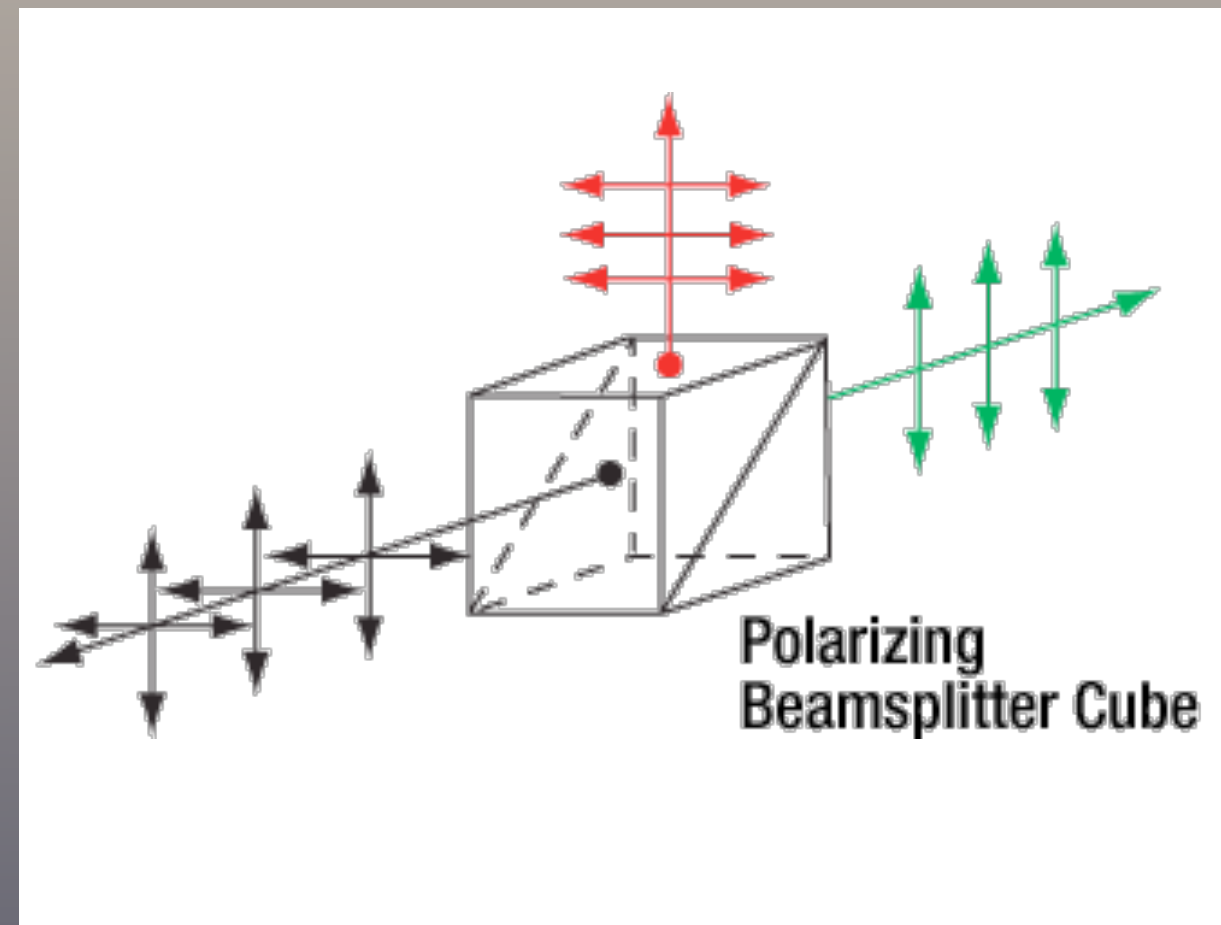

Basics...

Half -Wave Plate

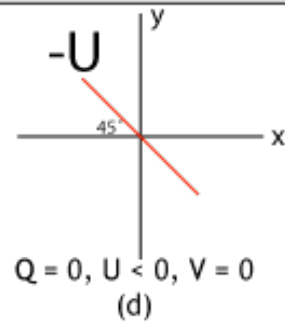
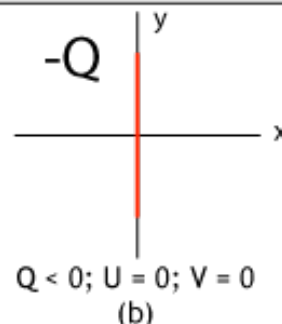
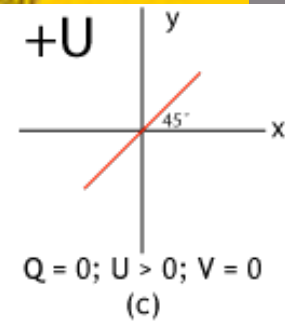
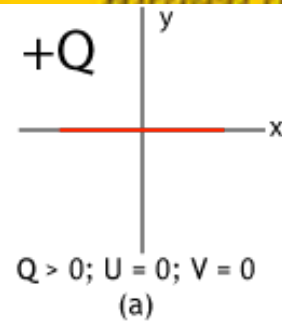
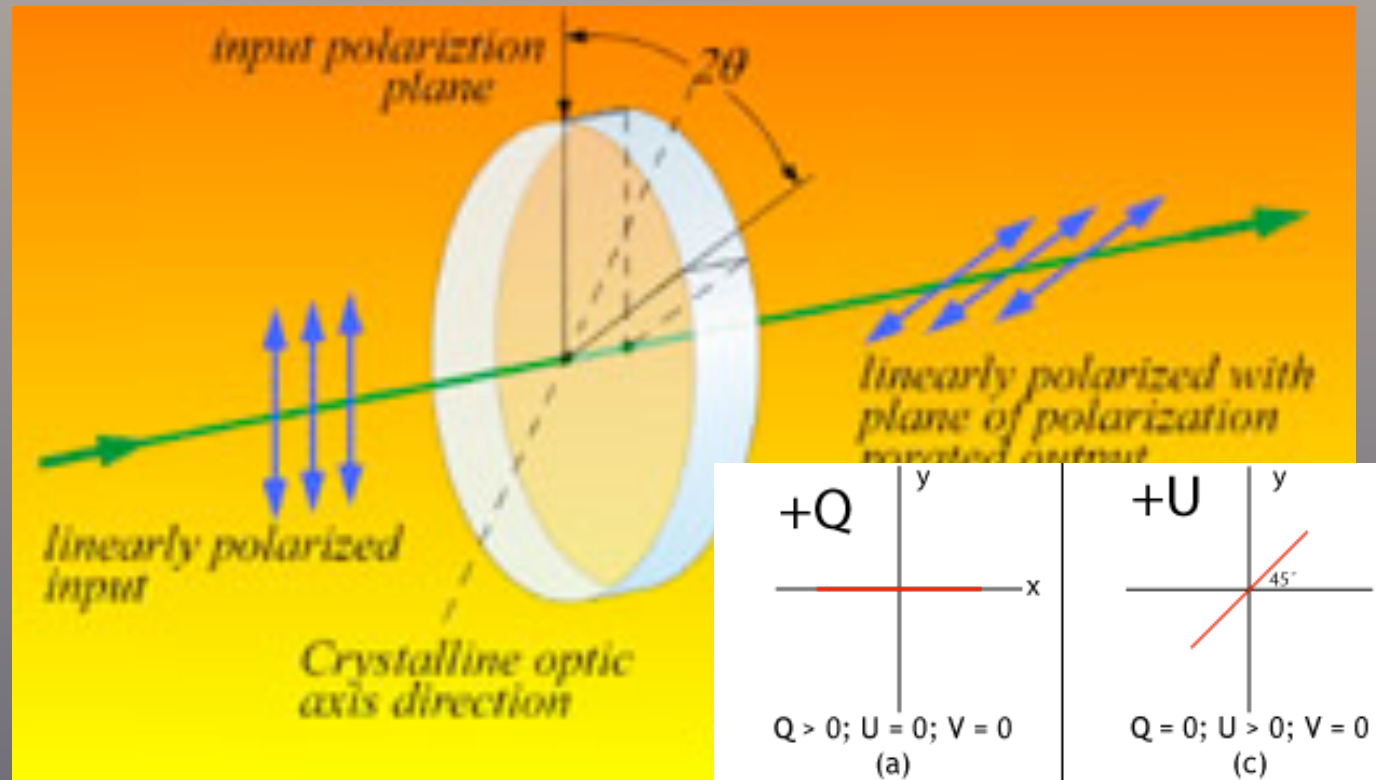

Beamsplitter

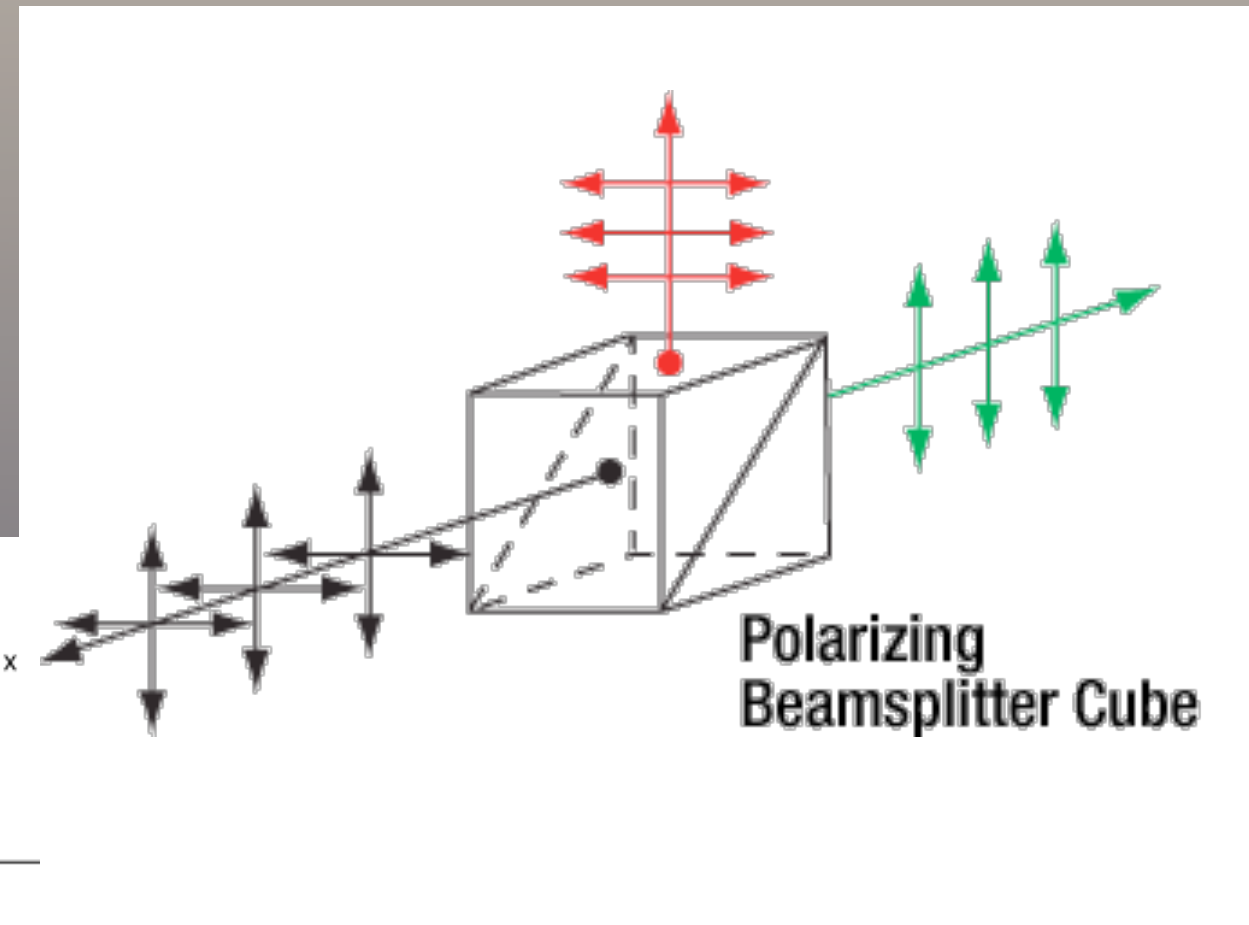

Differential technique

Dual-Beam Exchange Technique

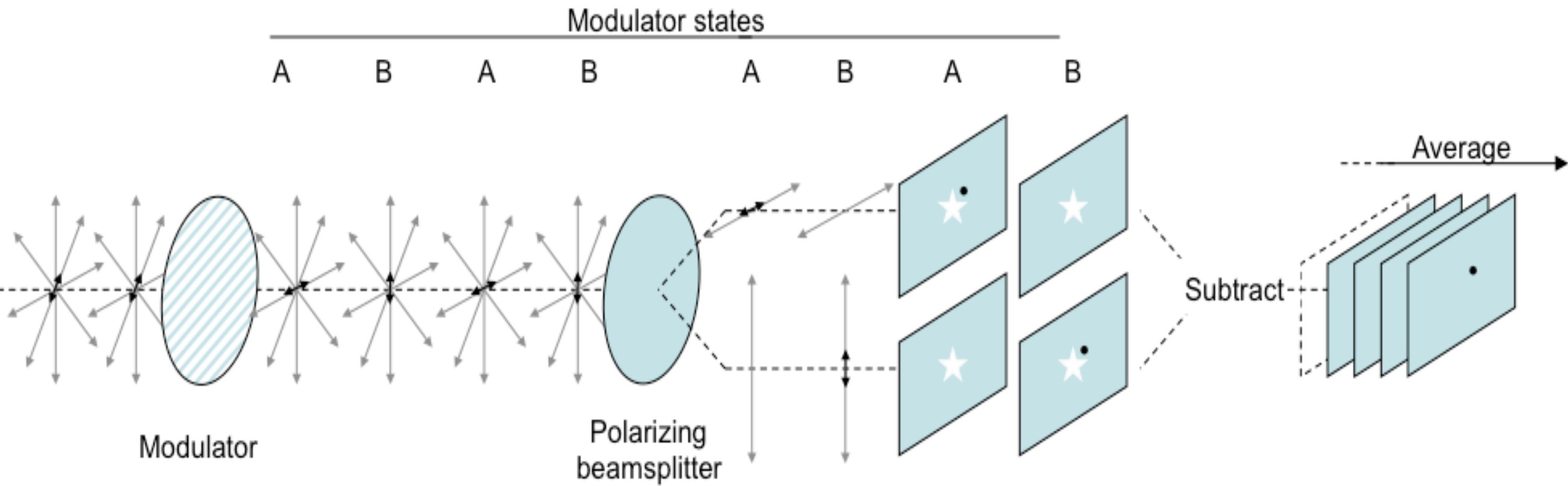



Differential technique

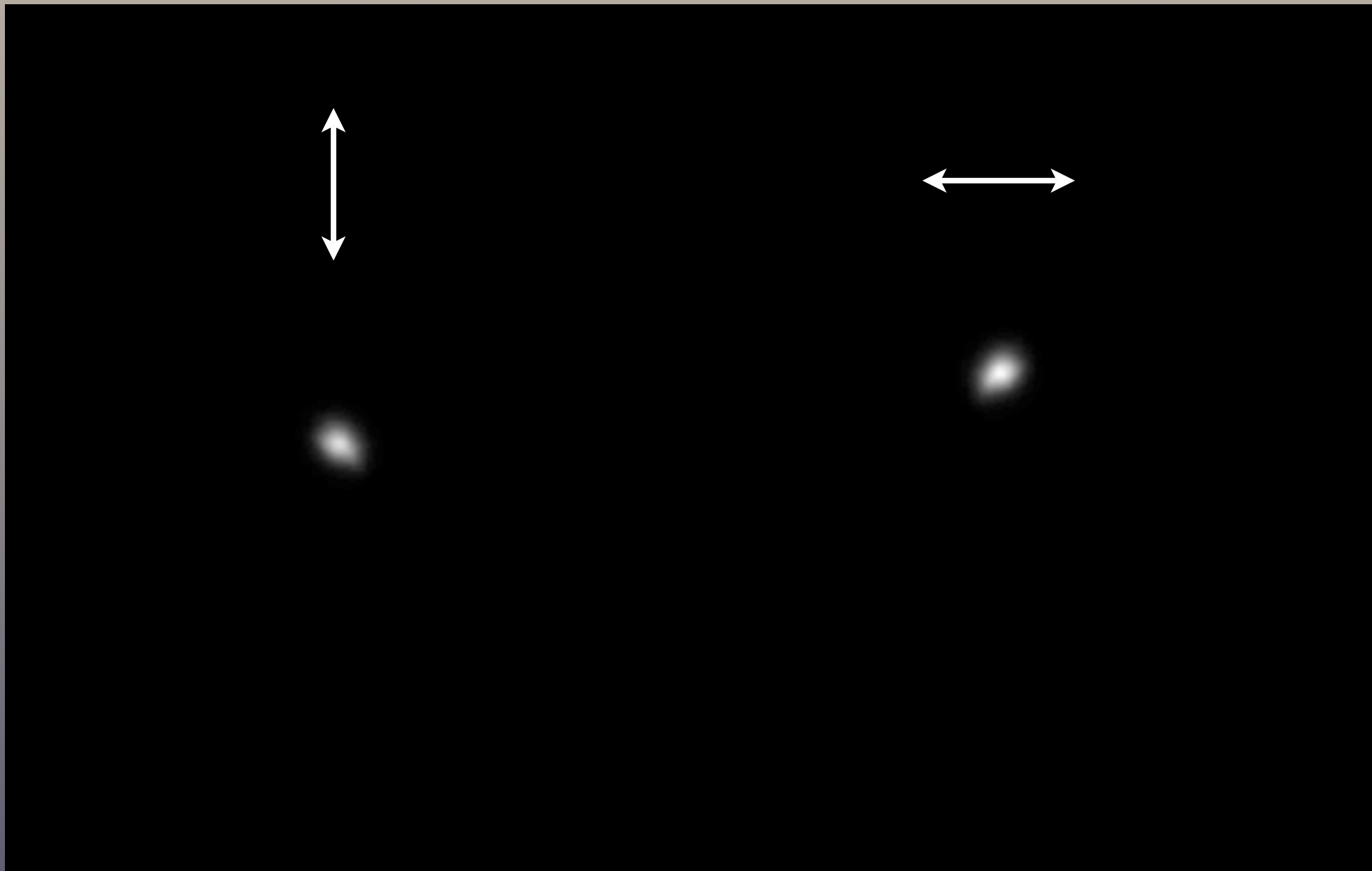



Differential technique

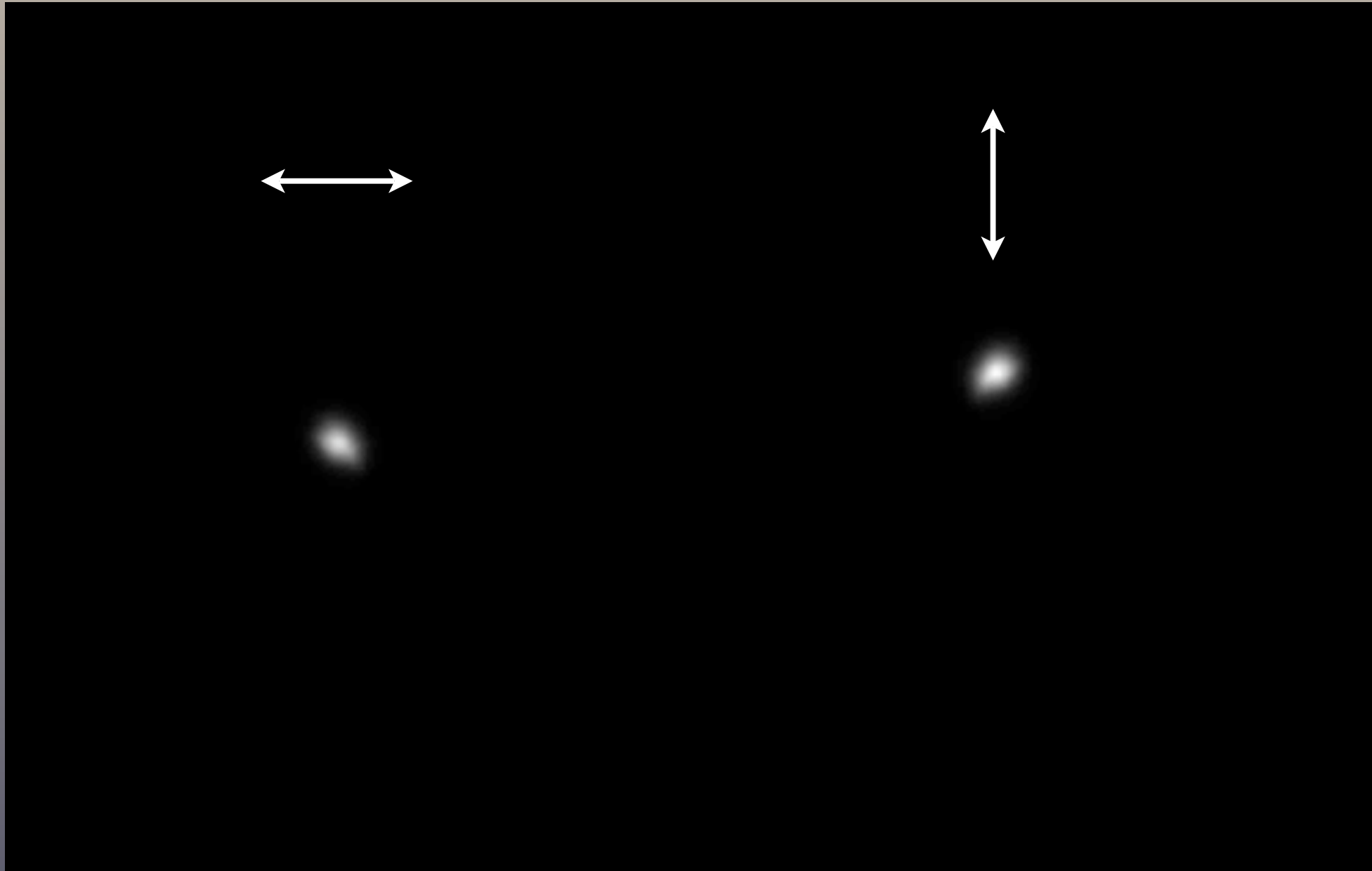



Differential technique

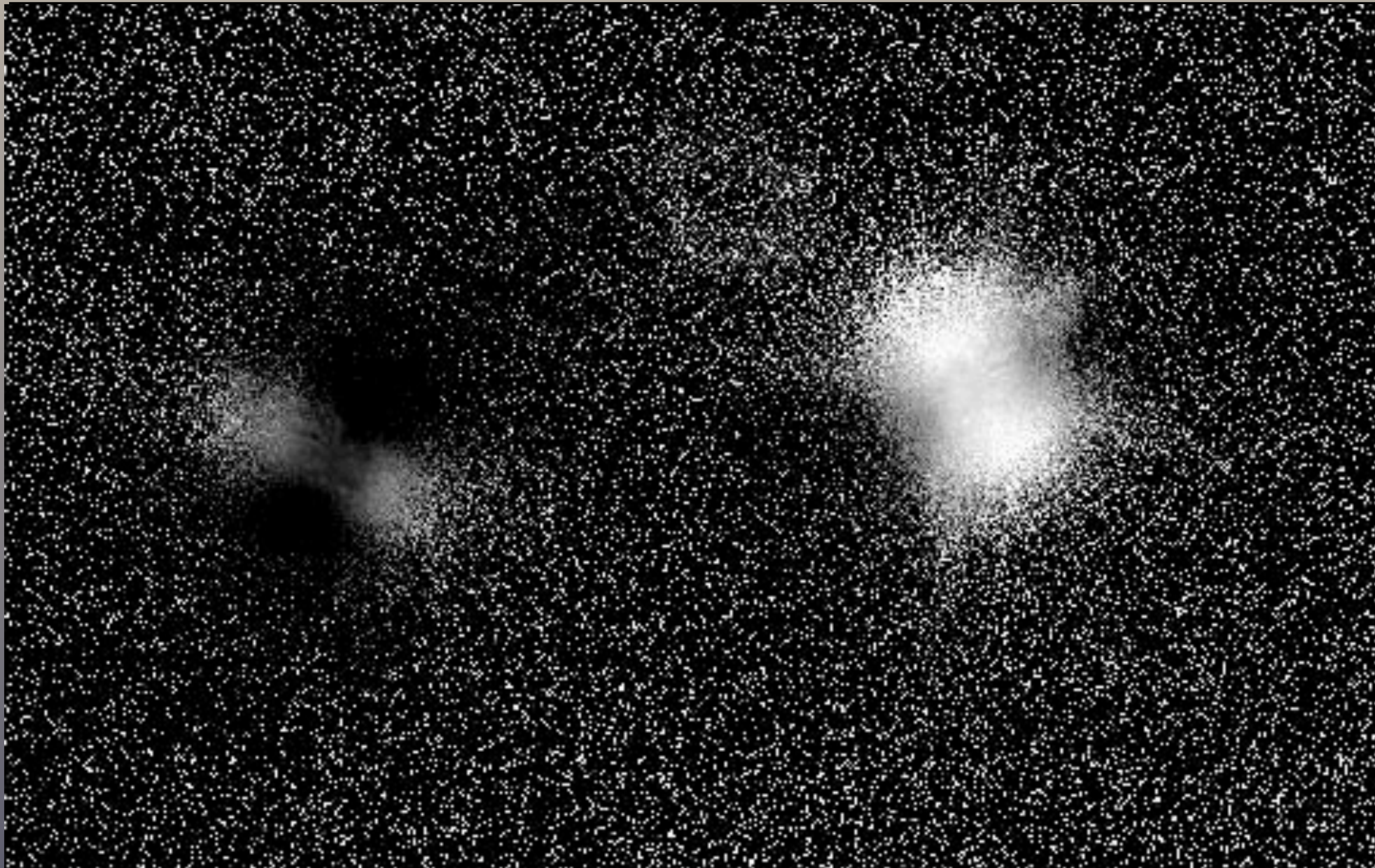



Imaging Polarimetry: Instrumentation

“One video” is worth 1000 words...



Imaging Polarimetry: Instrumentation

“One video” is worth 1000 words...

Exposure Time: 0.0560000 [seconds]

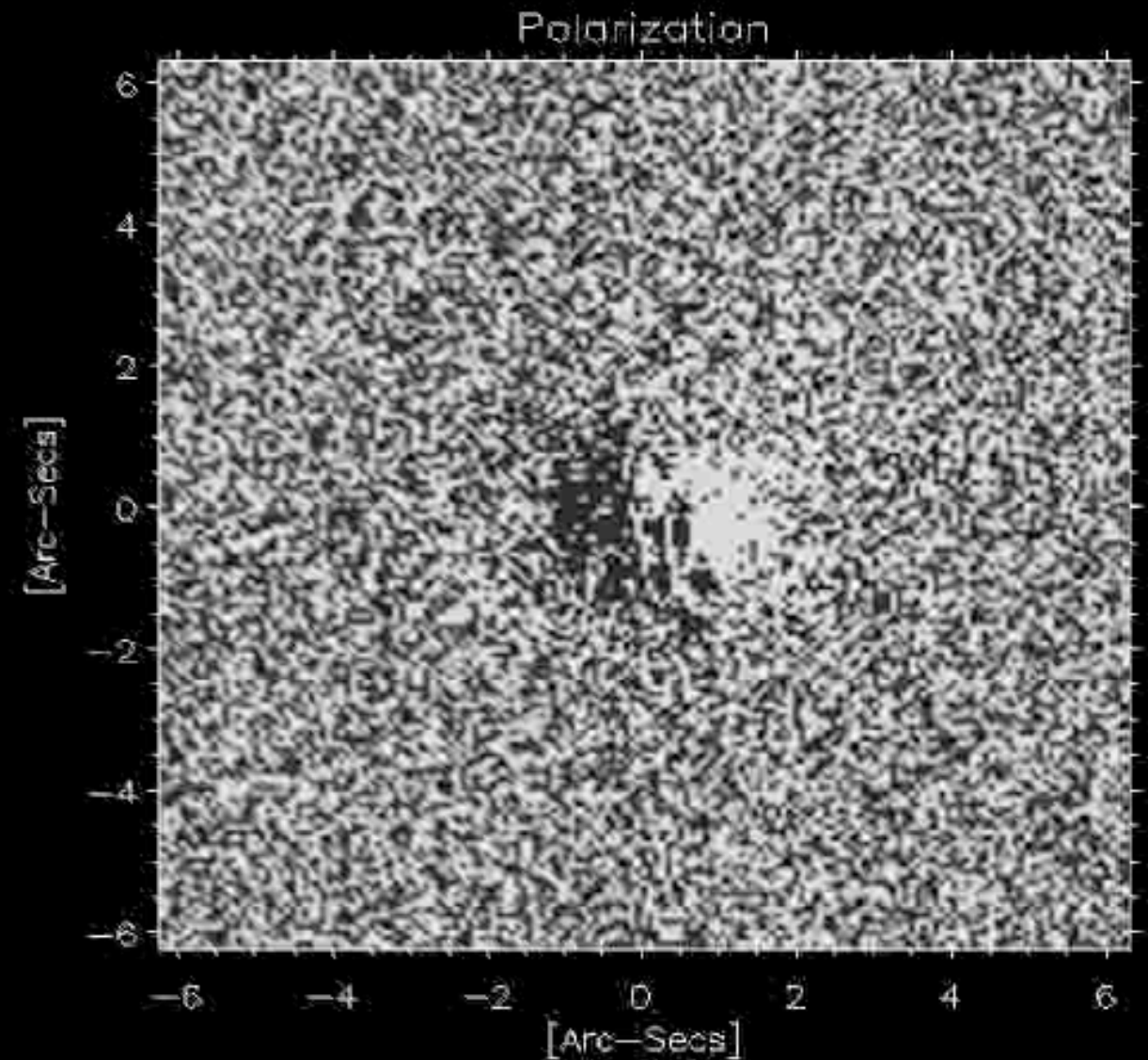
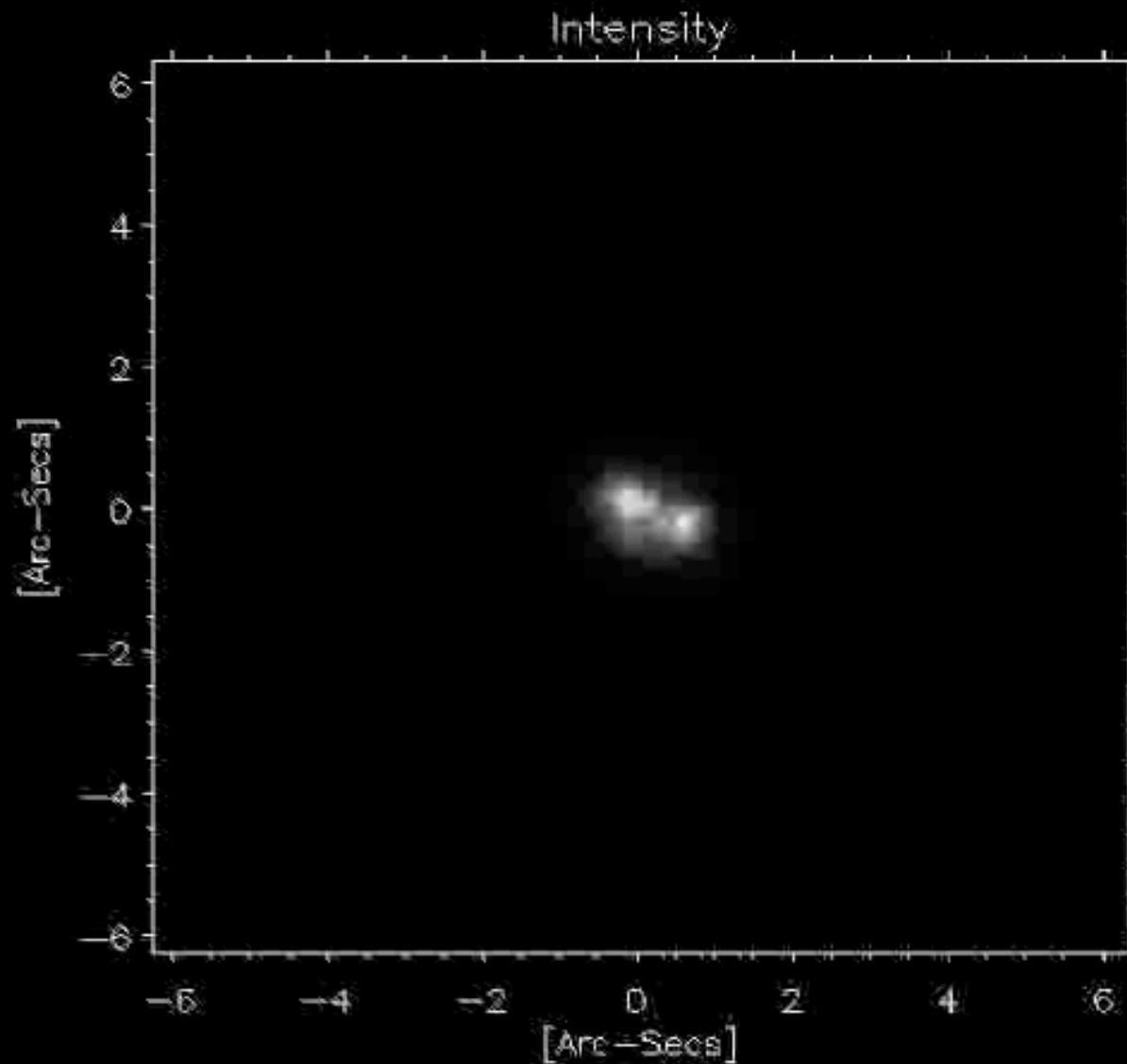



What are we talking??

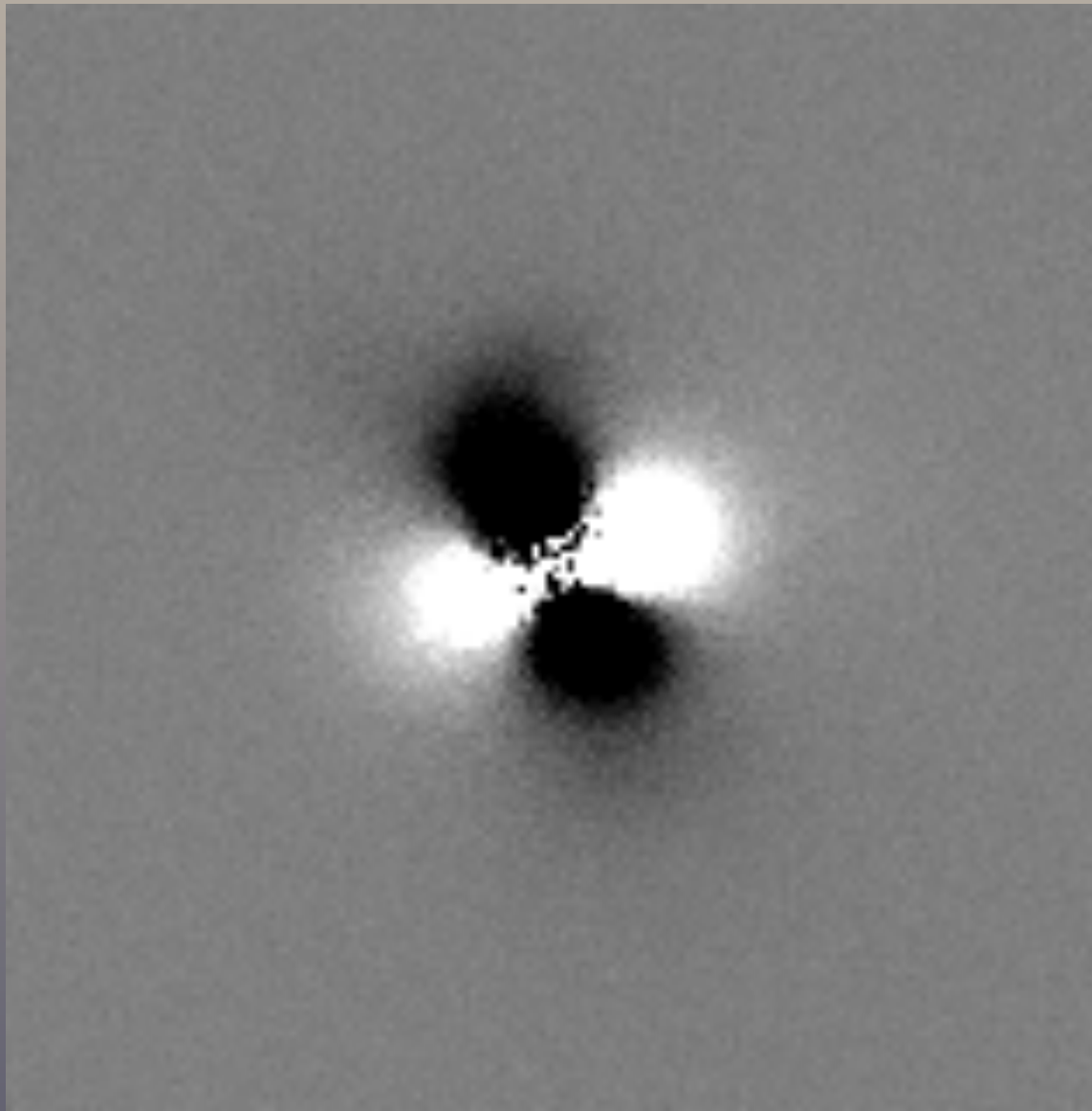

What are we talking about??

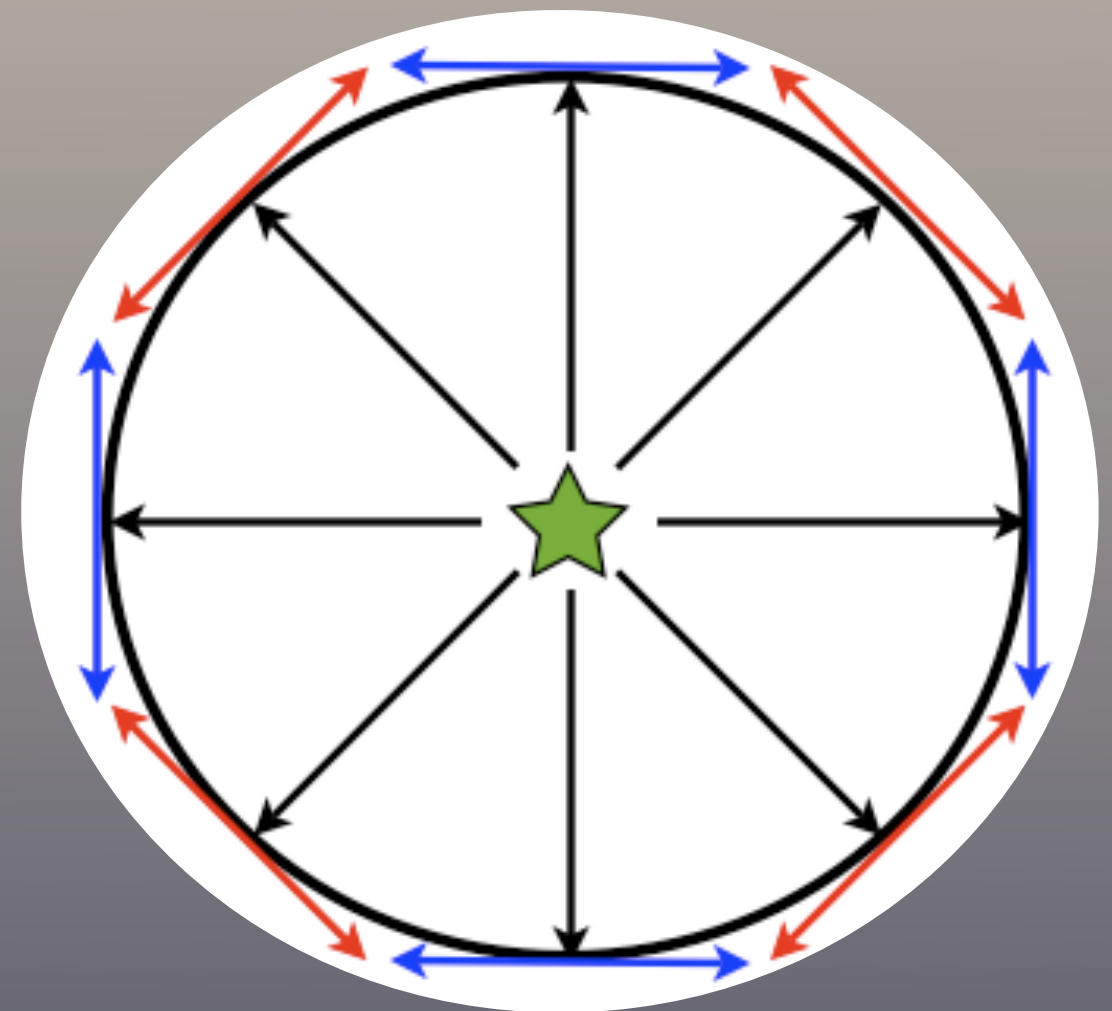
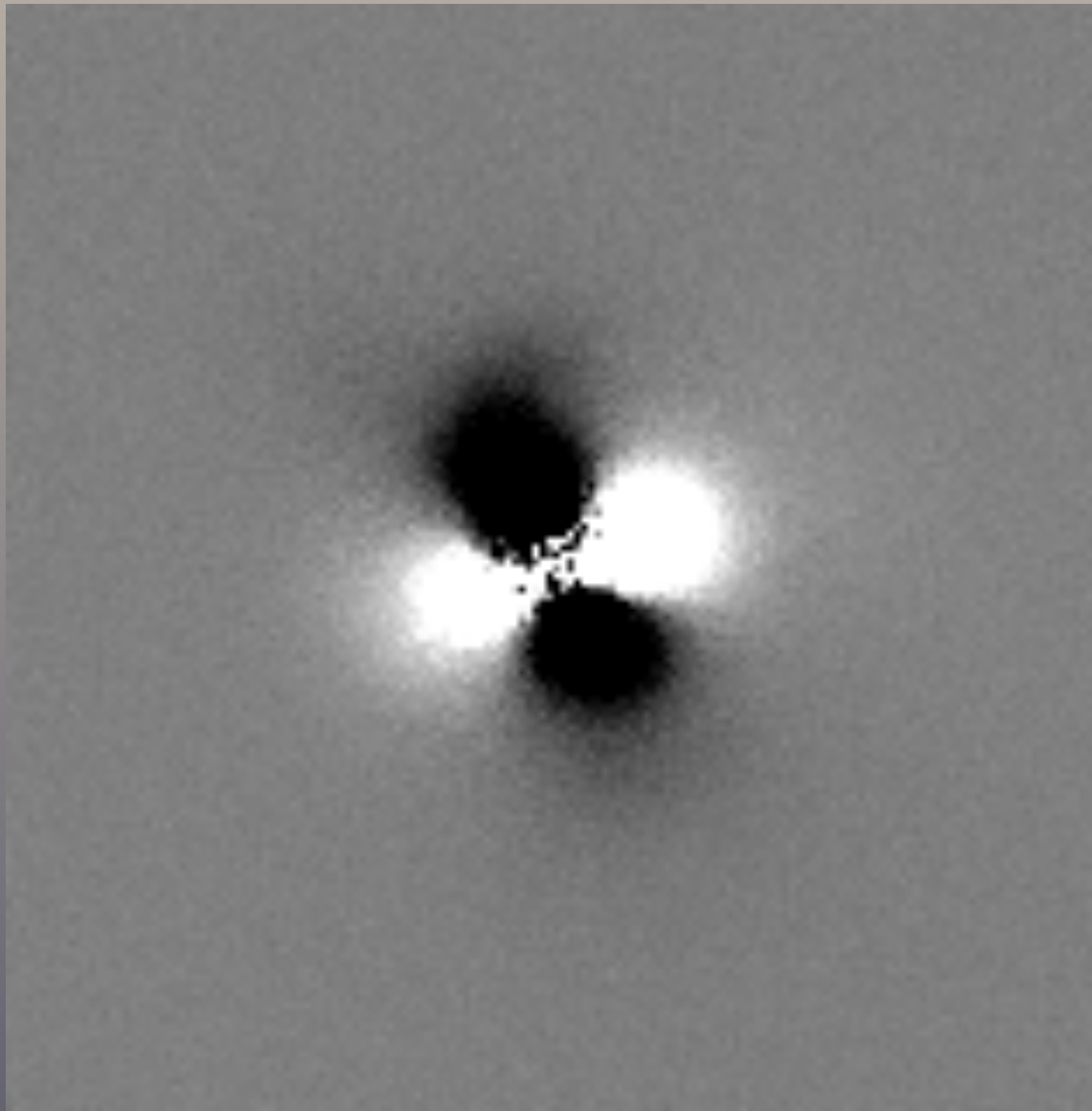

What are we talking??

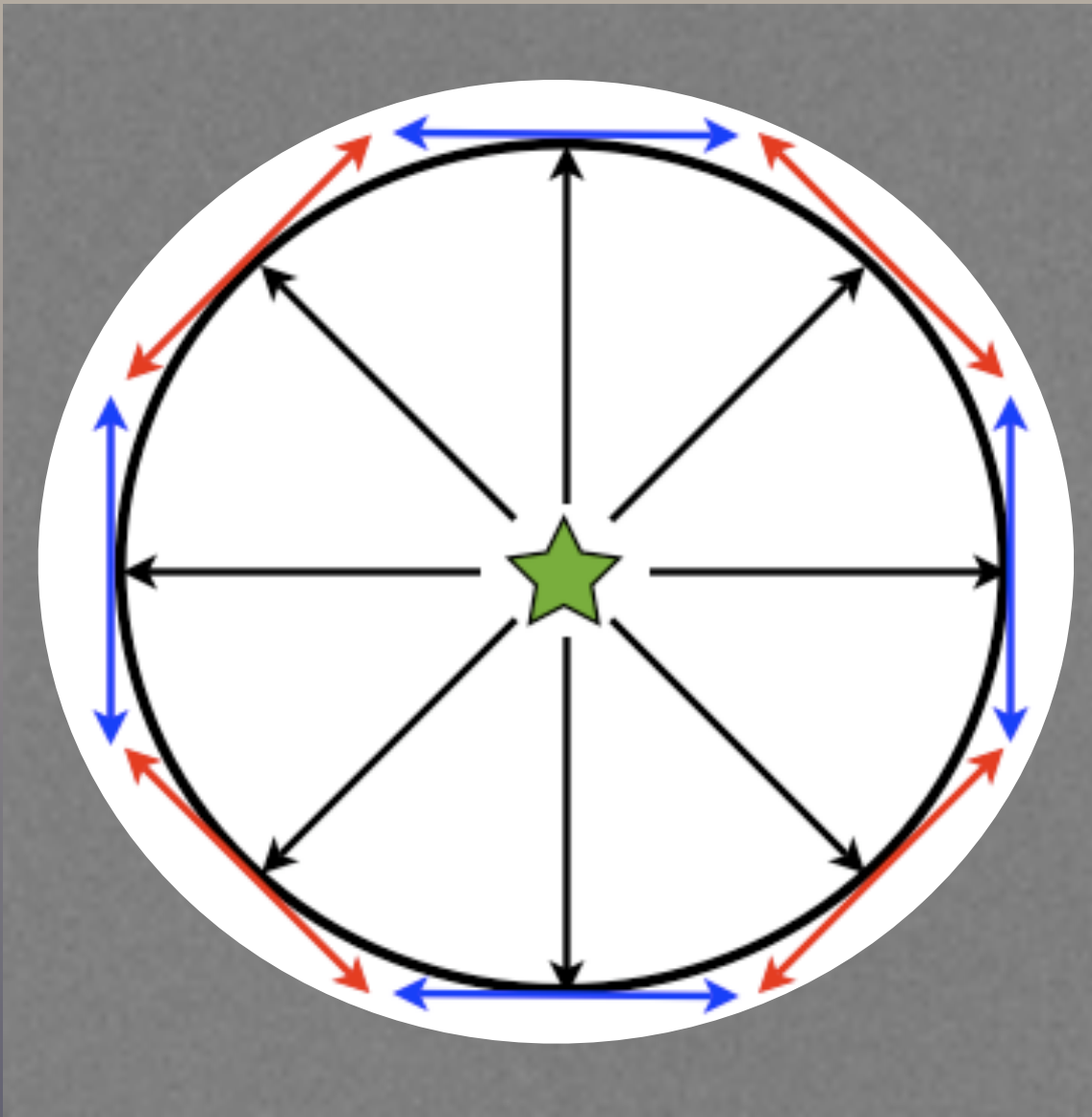

What are we talking??

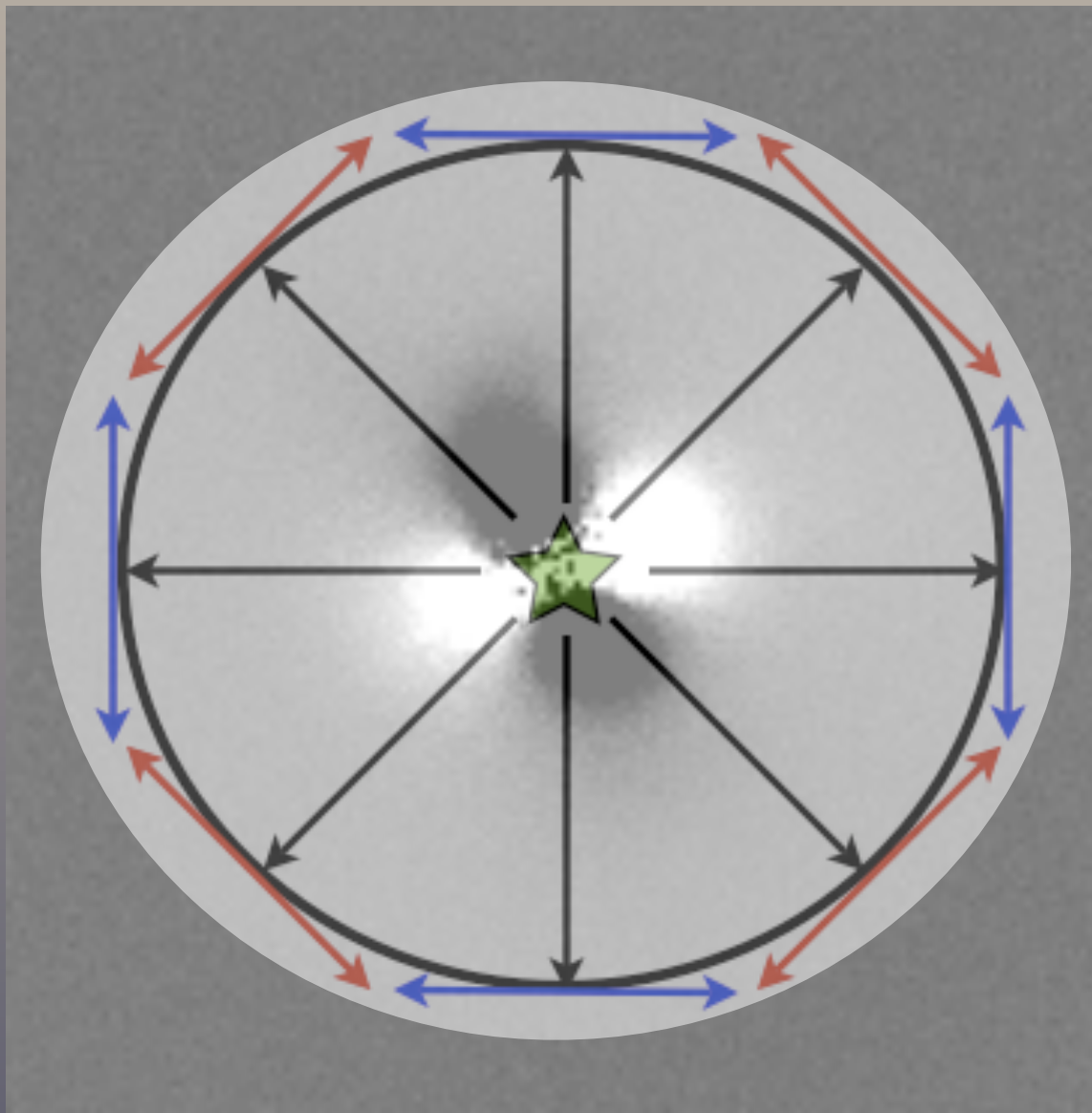



What are we talking??

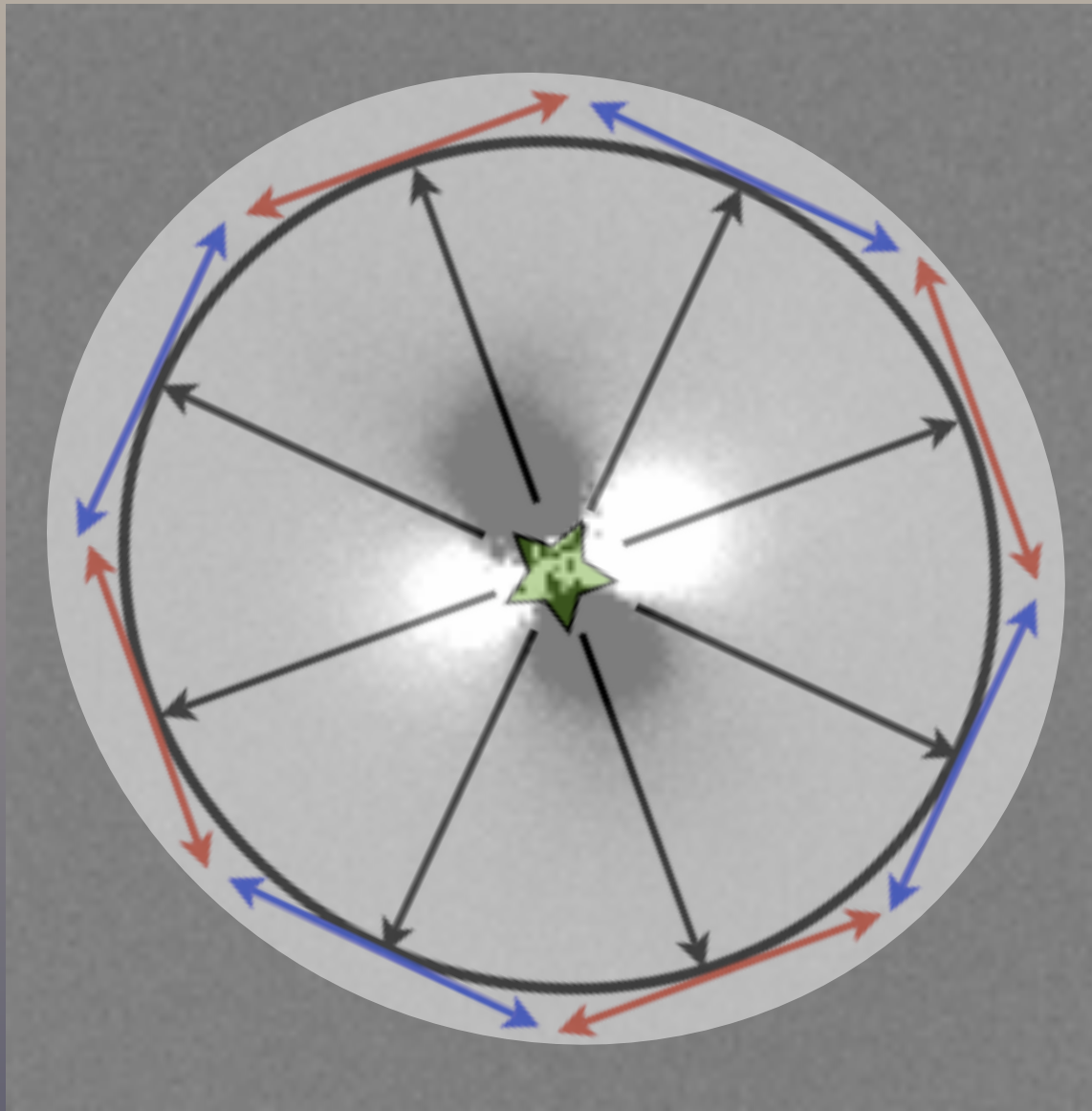

What are we talking??

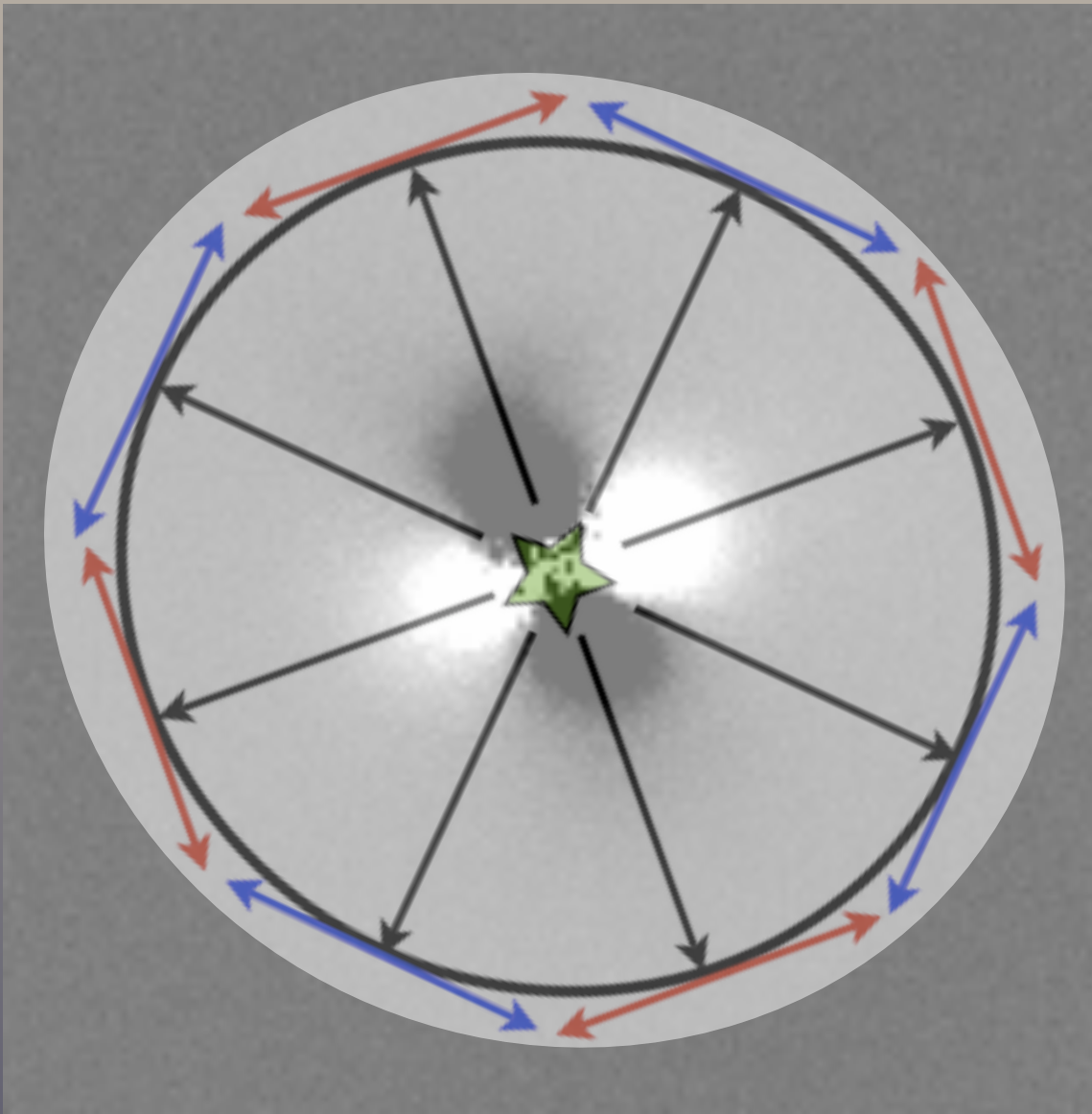

What are we talking about??

OK. Polarimetry works fine.
SO WHAT????

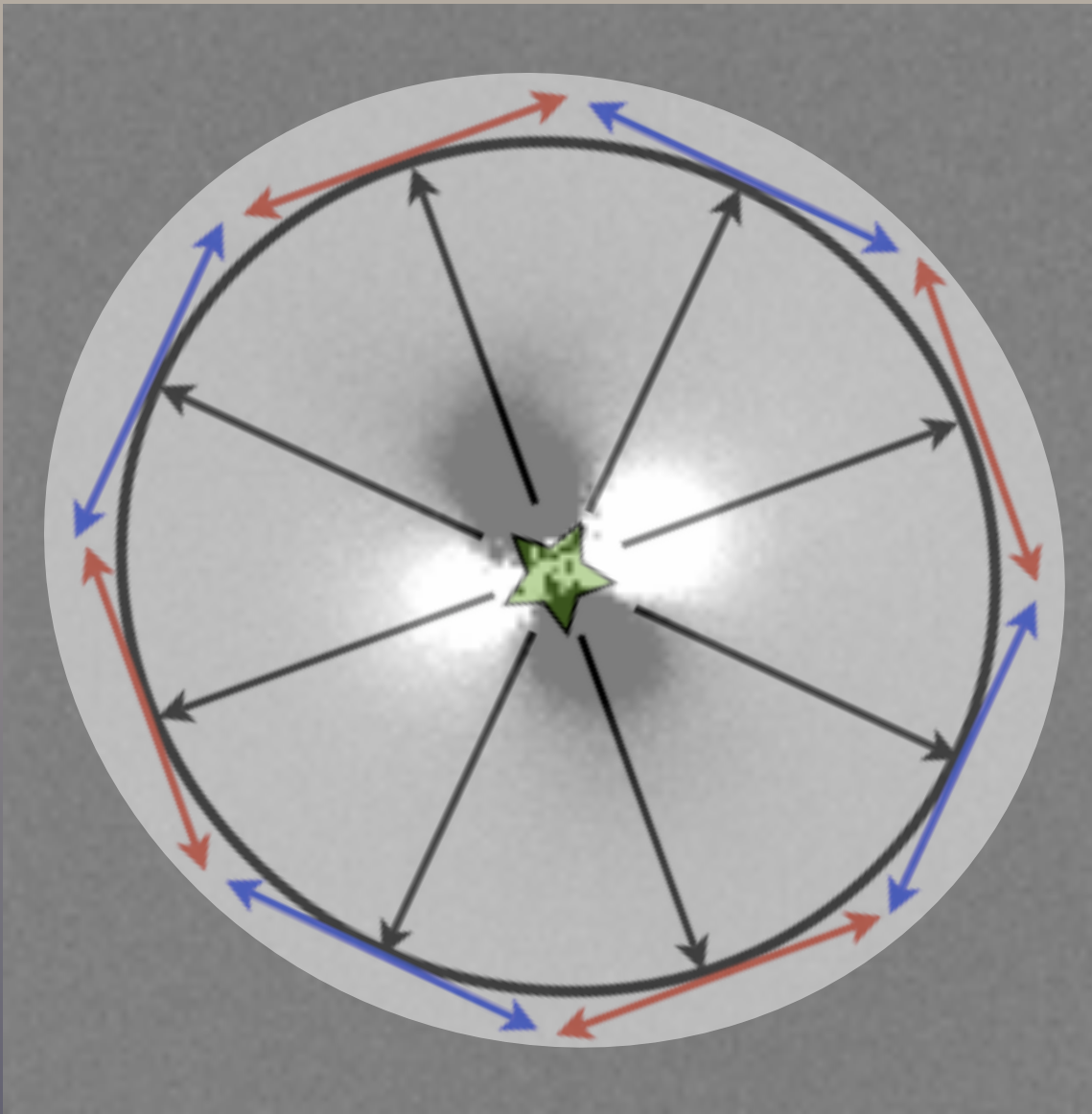

What are we talking about??

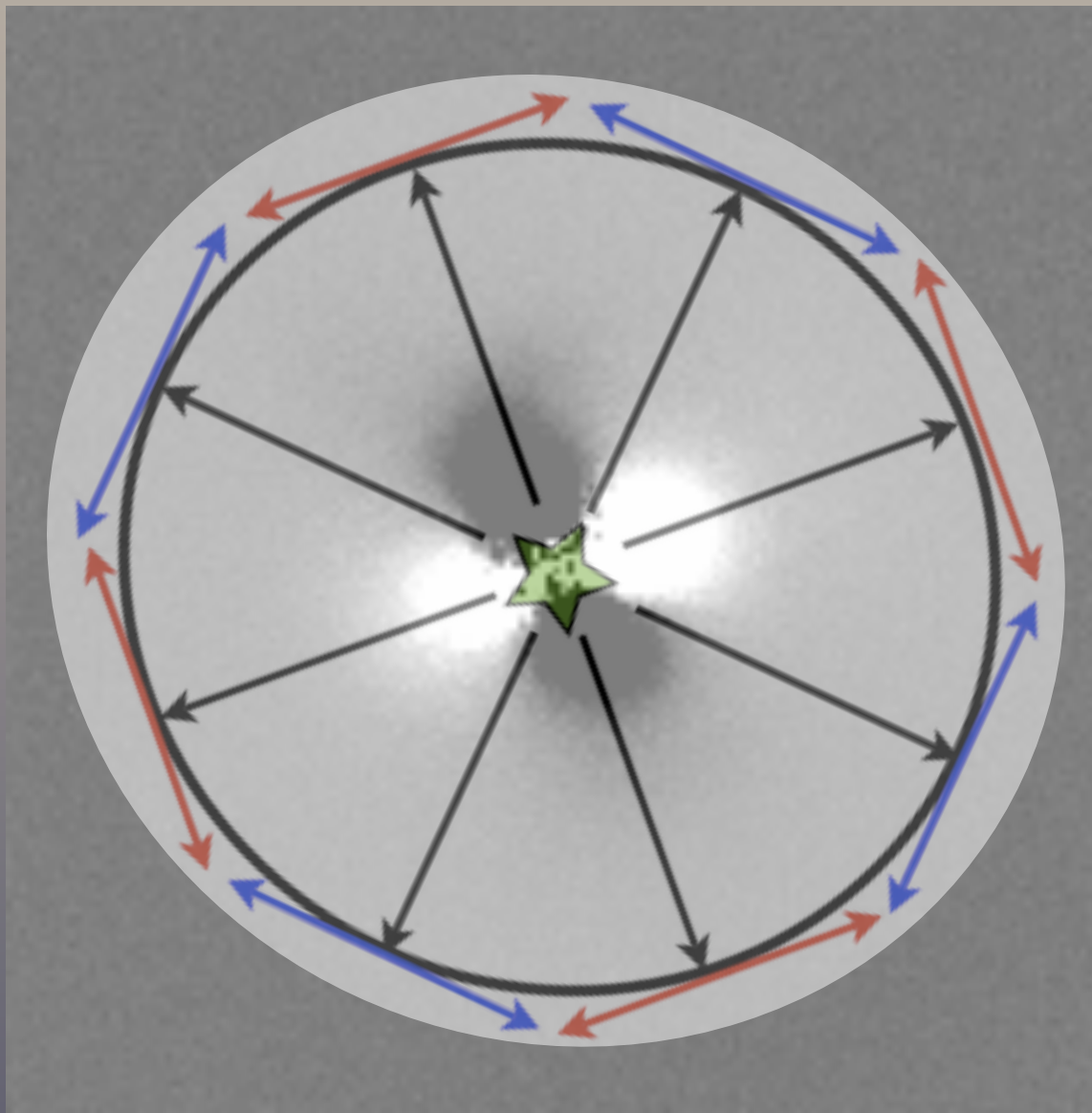

OK. Polarimetry works fine.
SO WHAT????

- Dust Properties
- Disk Orientation
- “Invisible Dust”
- Planets’ signature
- + Coronagraphs
- + Spectroscopy
- It is always hungry.... Photons!!

What are we talking about??

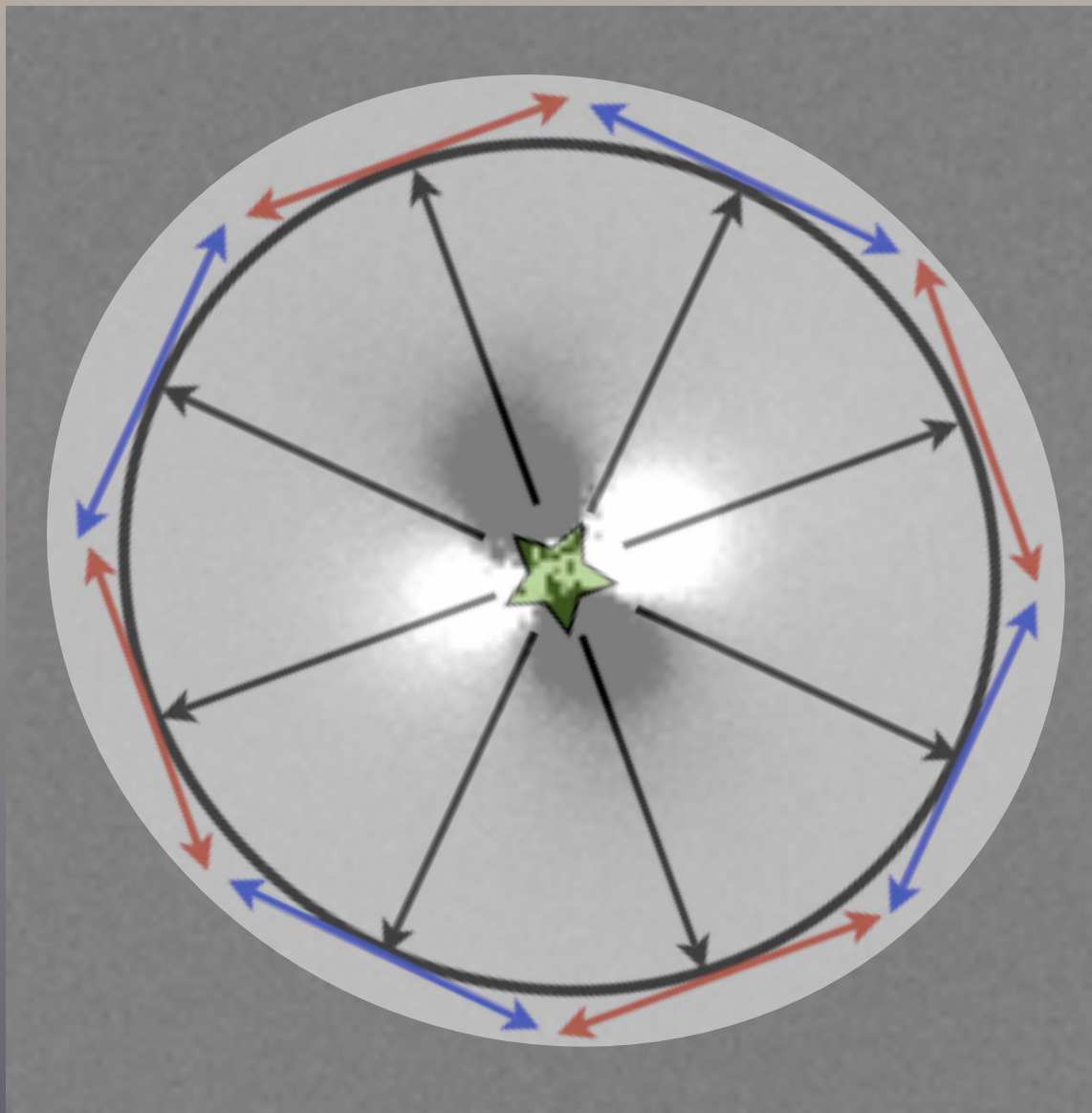

OK. Polarimetry works fine.
SO WHAT????

- Dust Properties
- Disk Orientation
- “Invisible Dust”
- Planets’ signature
- + Coronagraphs
- + Spectroscopy
- It is always hungry.... Photons!!





Differential technique

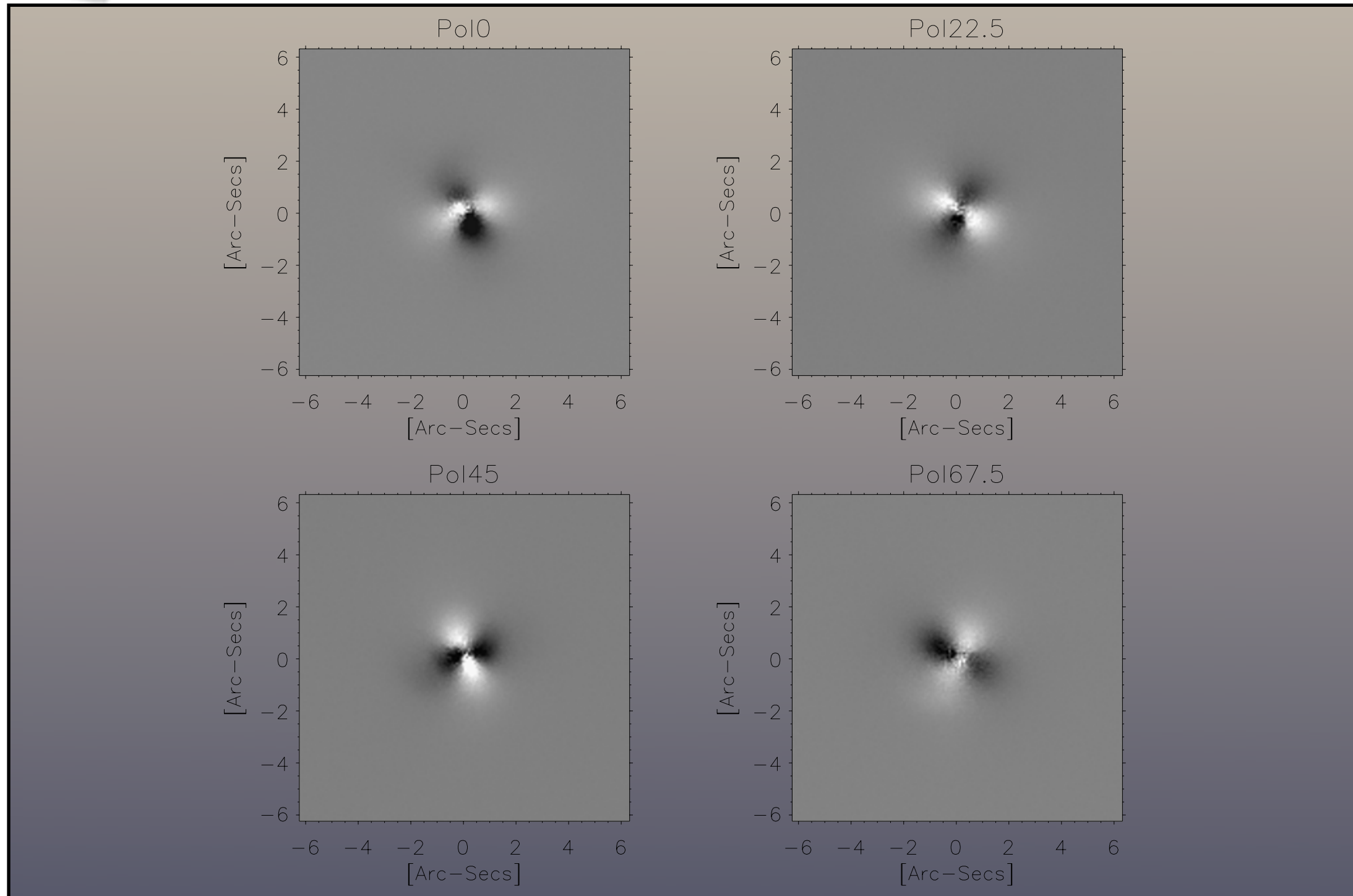



Differential technique

$+Q$

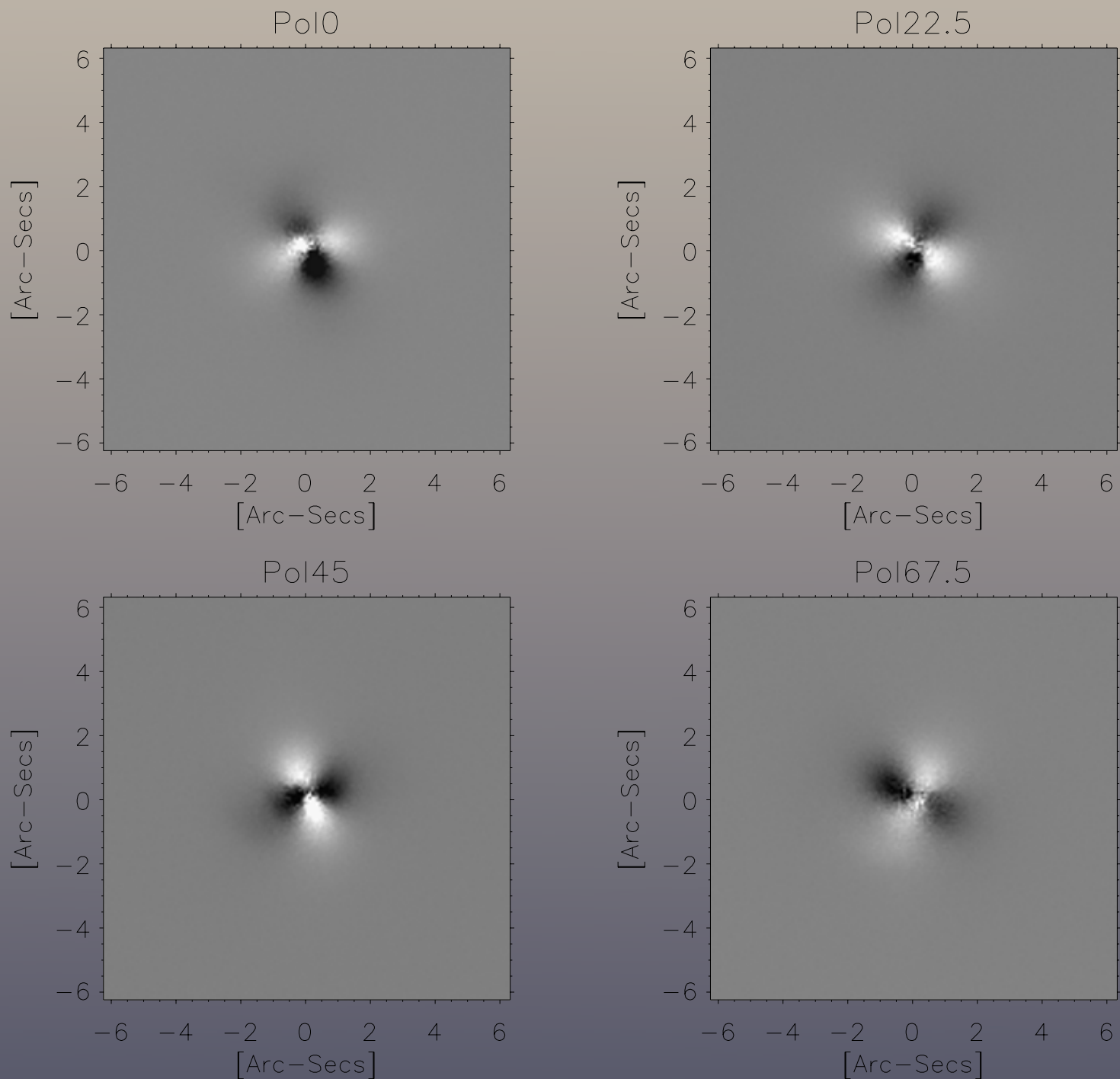



Differential technique

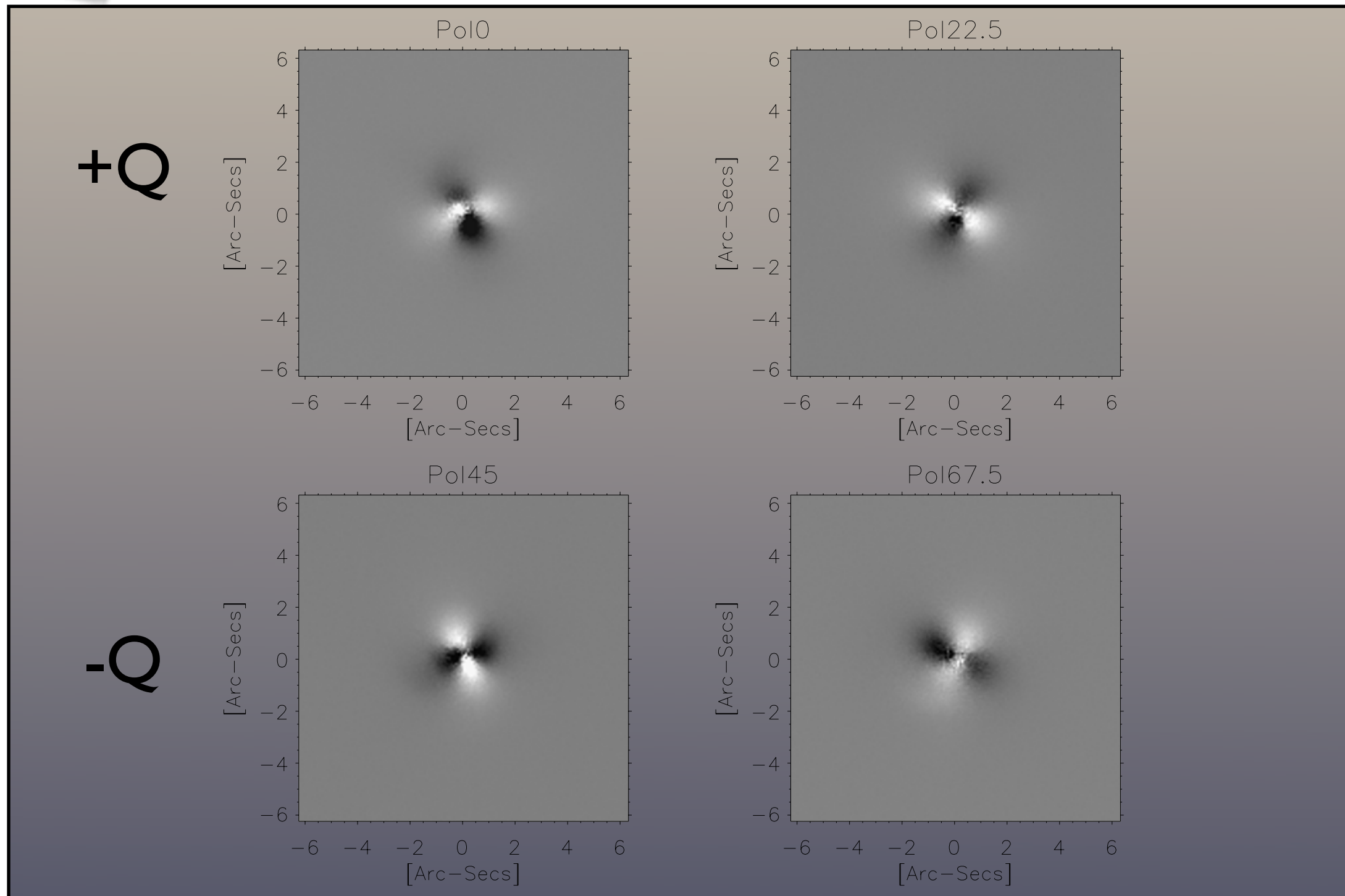



Differential technique

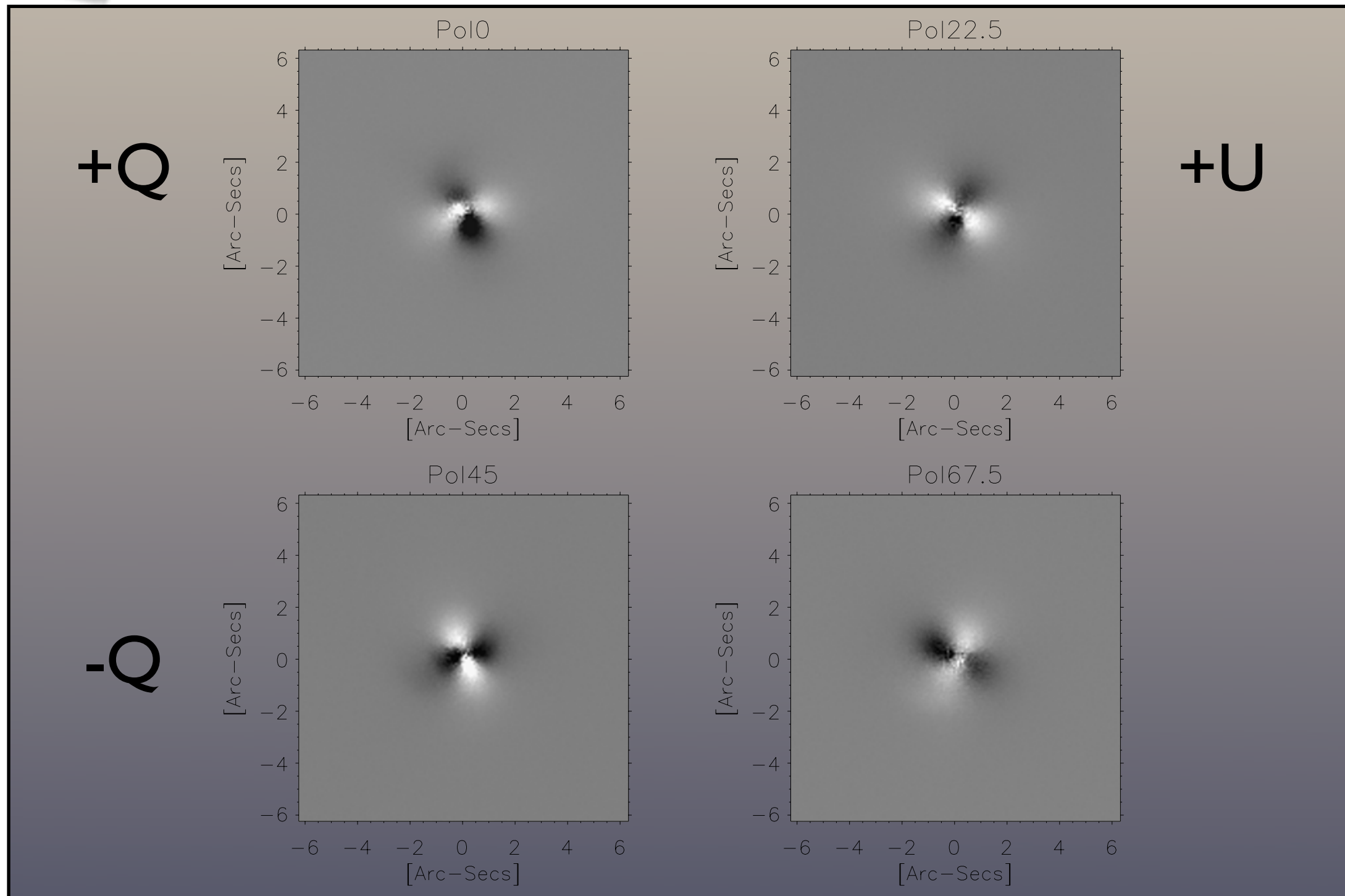



Differential technique

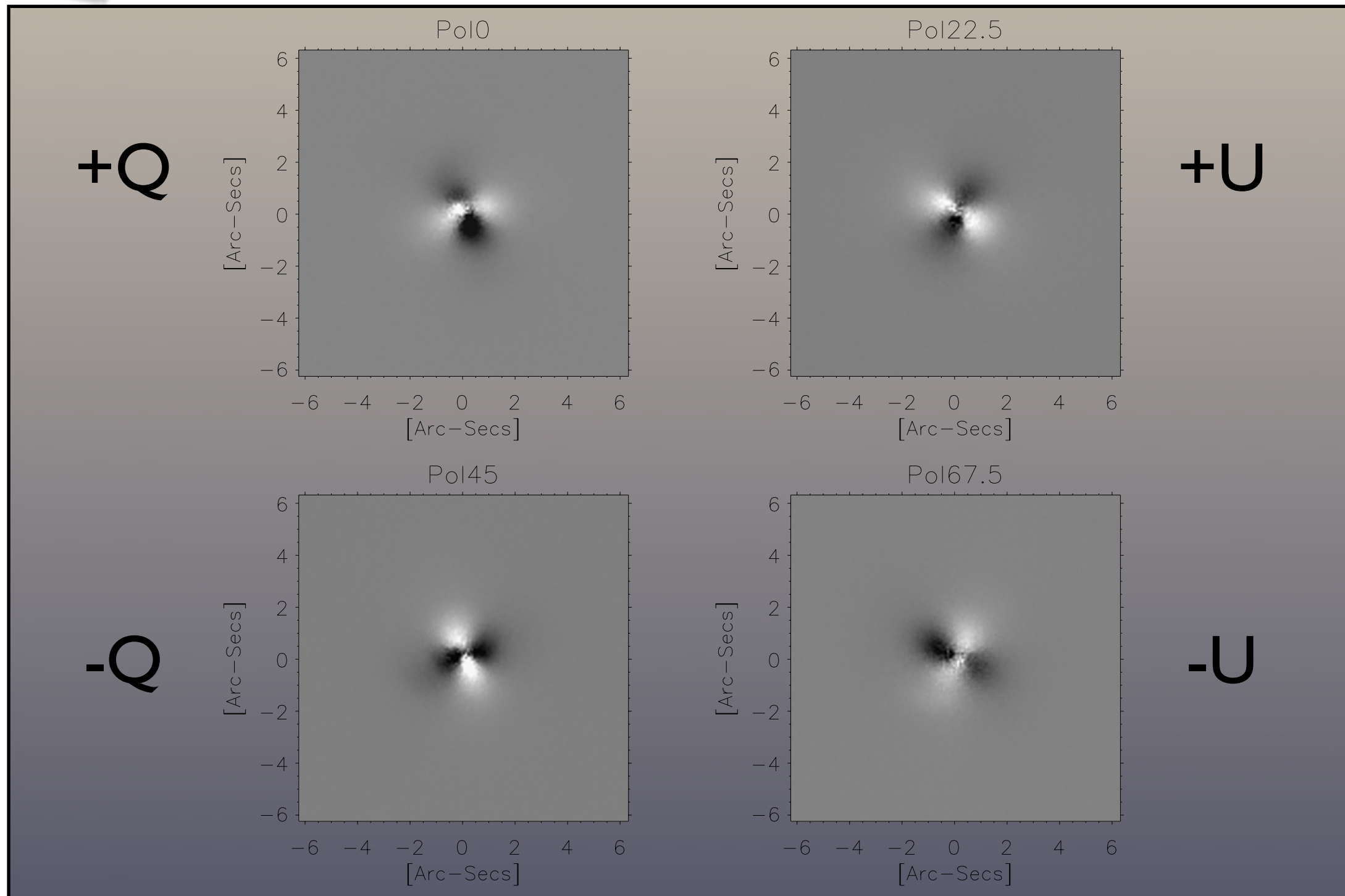



Instrumental Polarization: your enemy

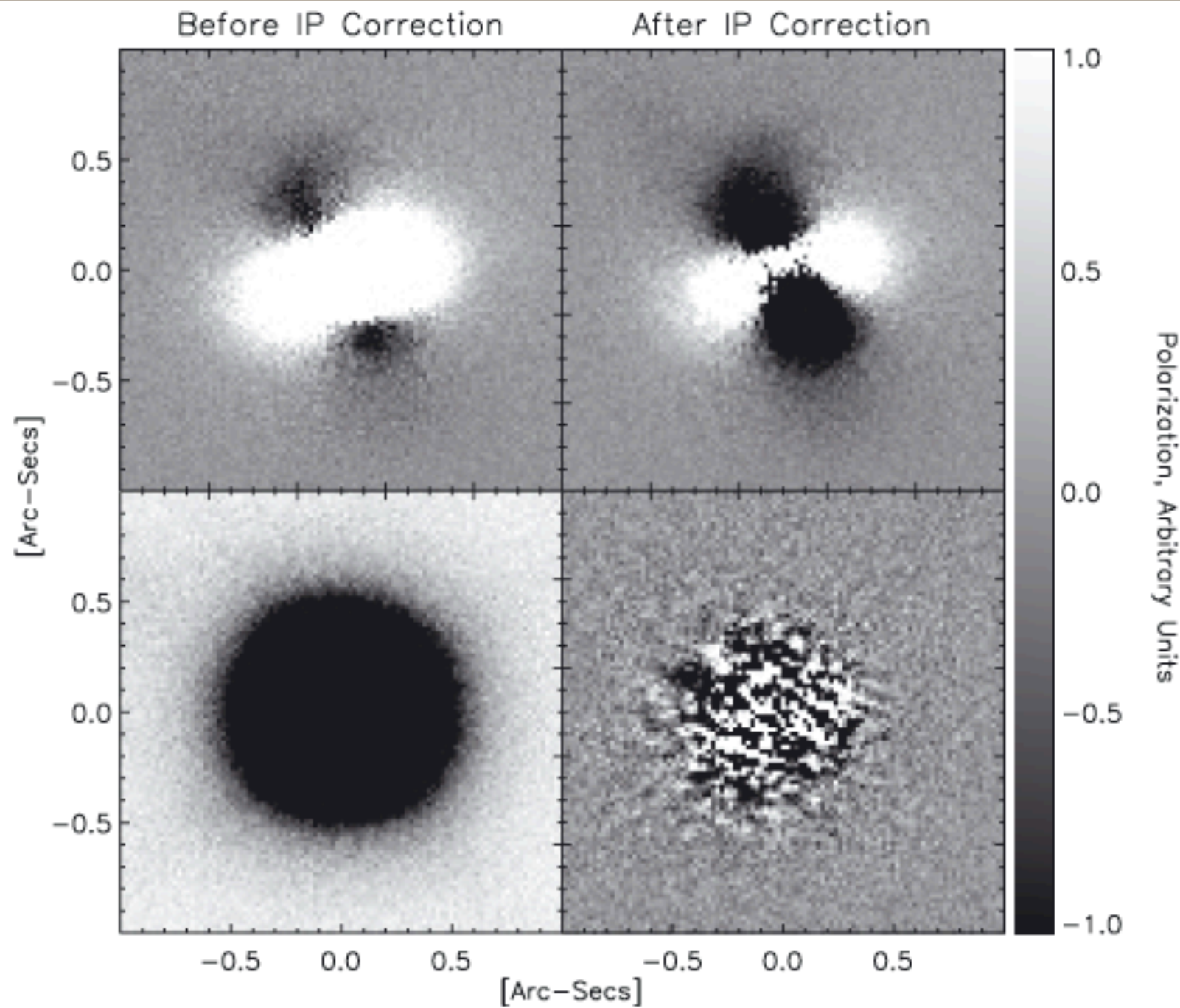



Instrumental Polarization: your enemy

Int

Stokes Q

Stokes U

P

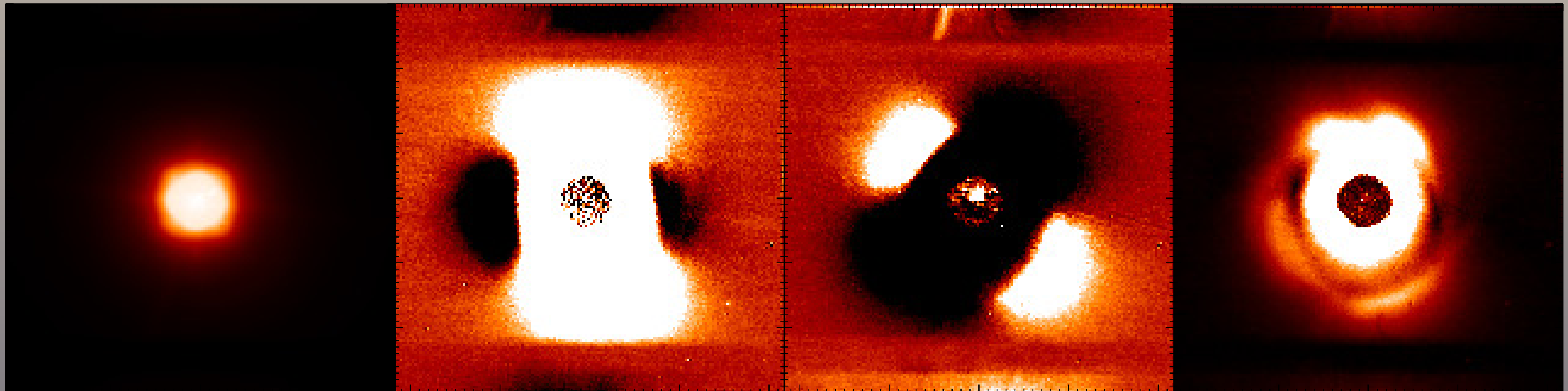

-2 -1 0 1 2
[Arc-Secs]

-2 -1 0 1 2
[Arc-Secs]

-2 -1 0 1 2
[Arc-Secs]

-2 -1 0 1 2
[Arc-Secs]



IP corrected...

Int

Stokes Q

Stokes U

P

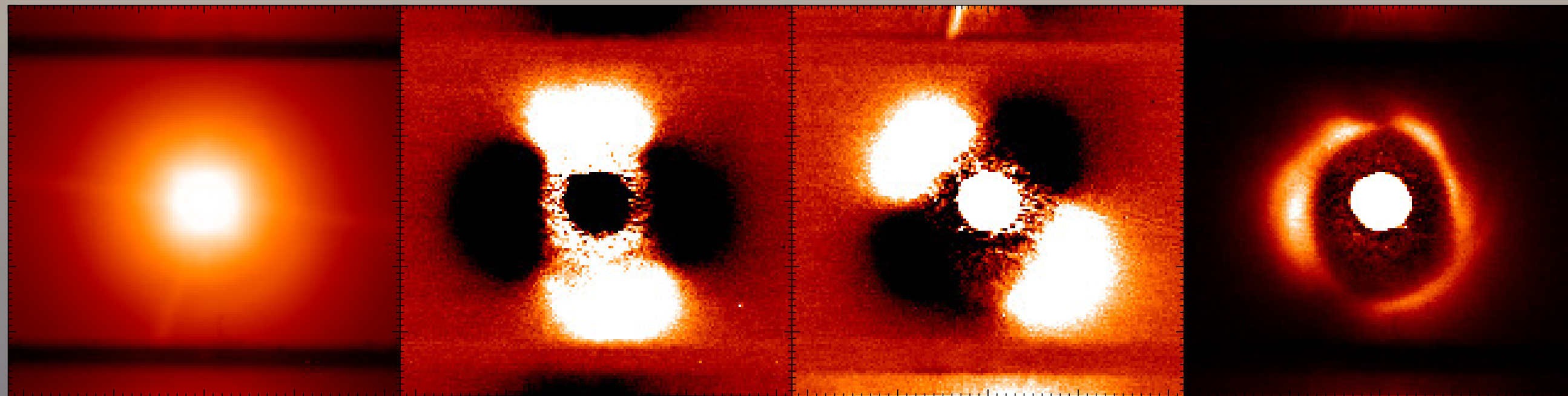

-2 -1 0 1 2
[Arc-Secs]

-2 -1 0 1 2
[Arc-Secs]

-2 -1 0 1 2
[Arc-Secs]

-2 -1 0 1 2
[Arc-Secs]



How do we know is well corrected???

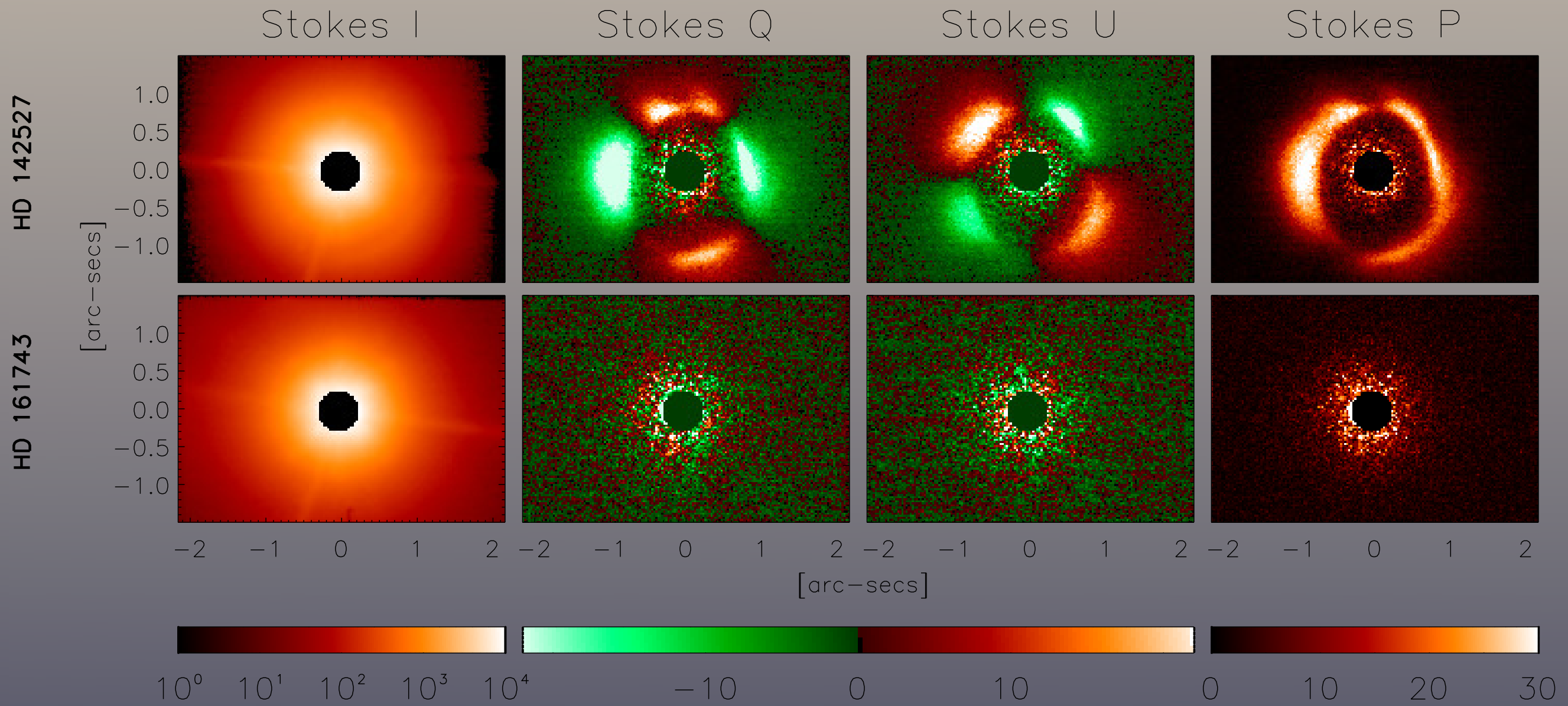

Hunting the Polarization Degree

$$P_I = \sqrt{Q^2 + U^2}$$

PSF-subtracted

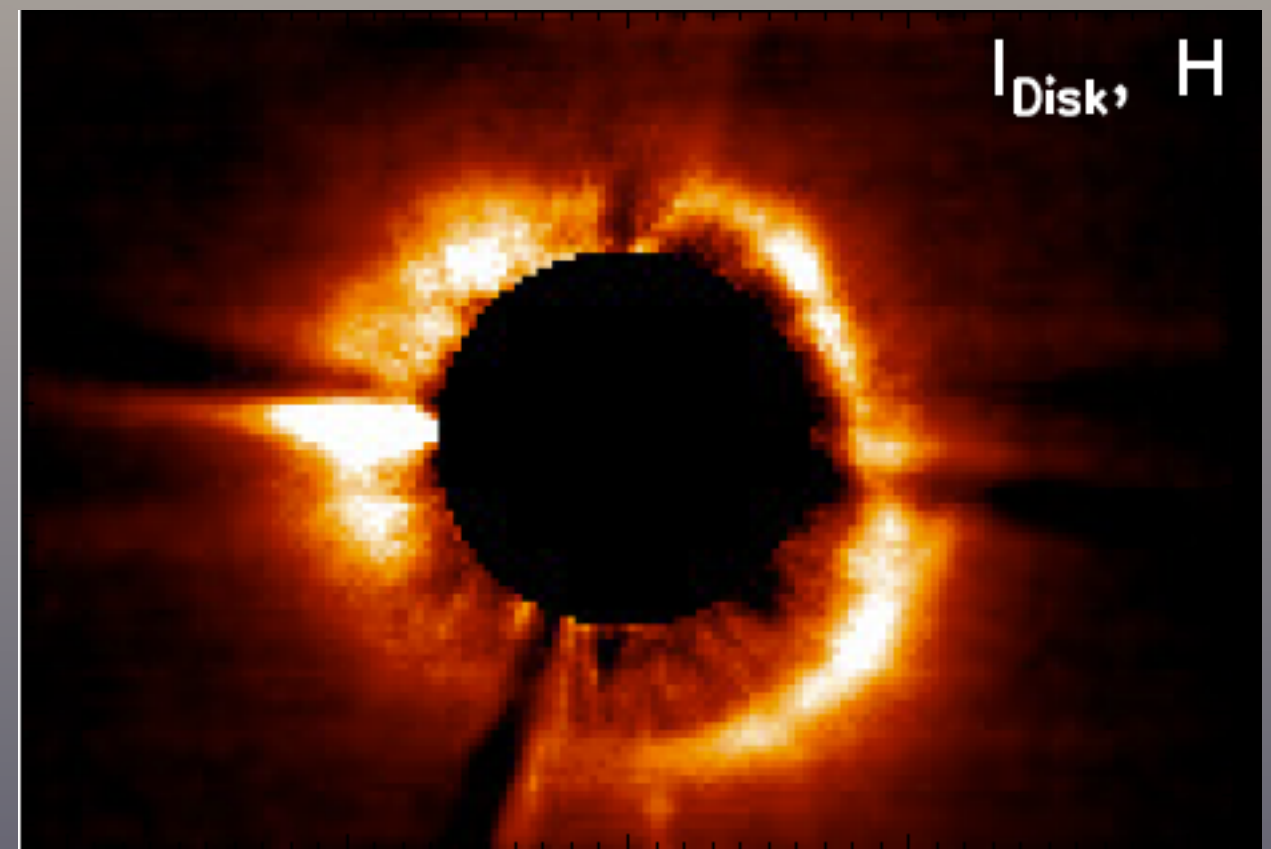
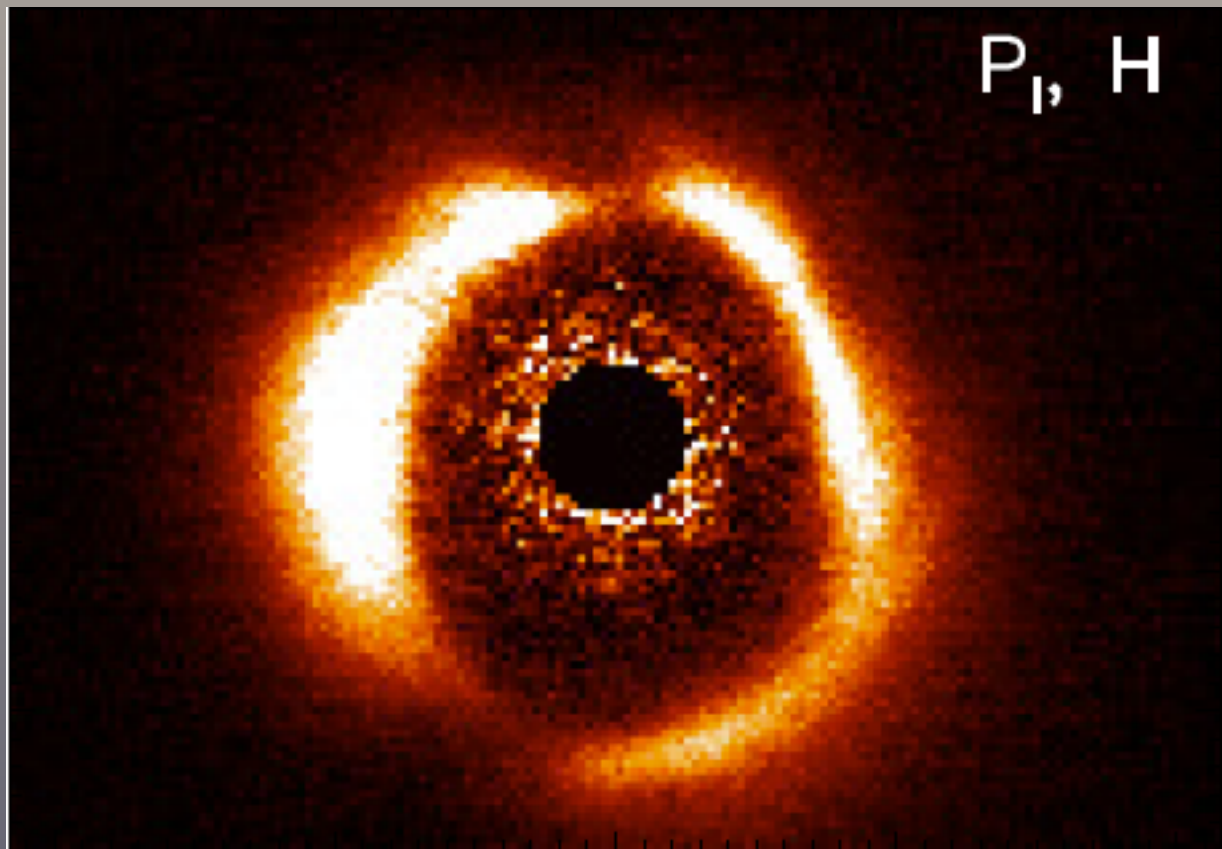

Hunting the Polarization Degree

$$P_I = \sqrt{Q^2 + U^2}$$

PSF-subtracted

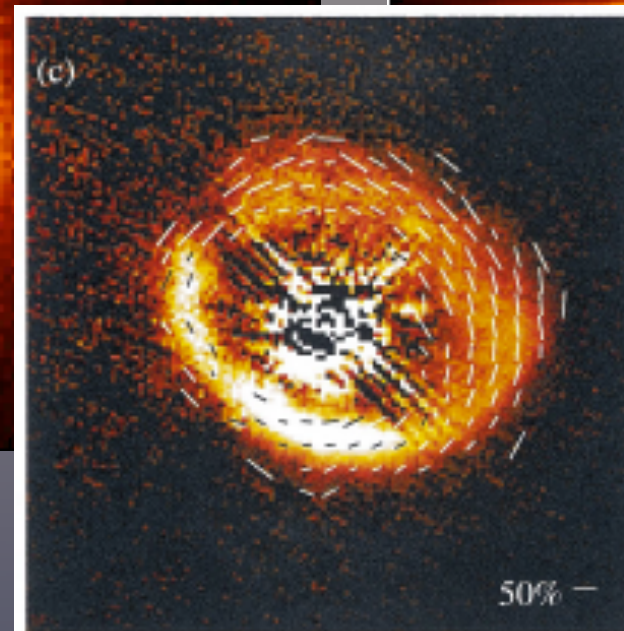
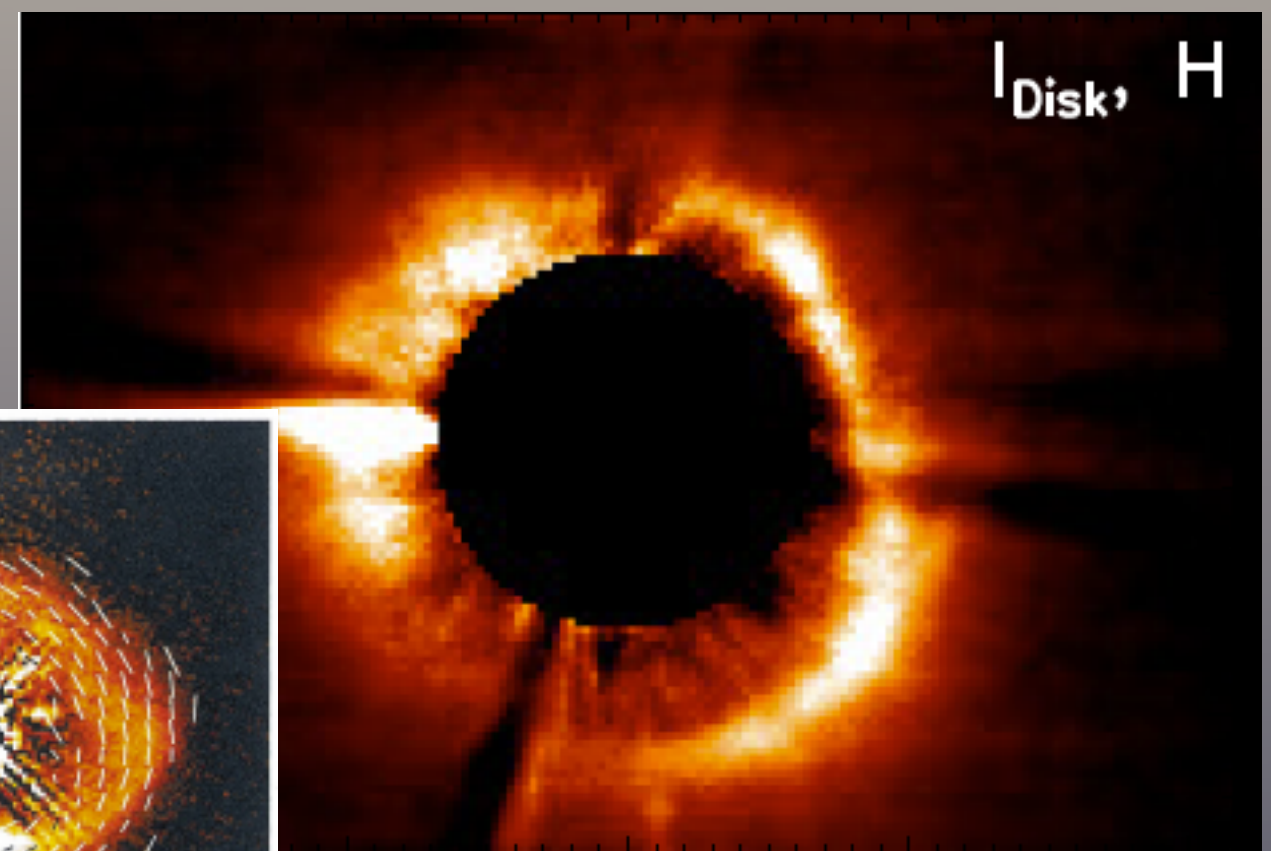
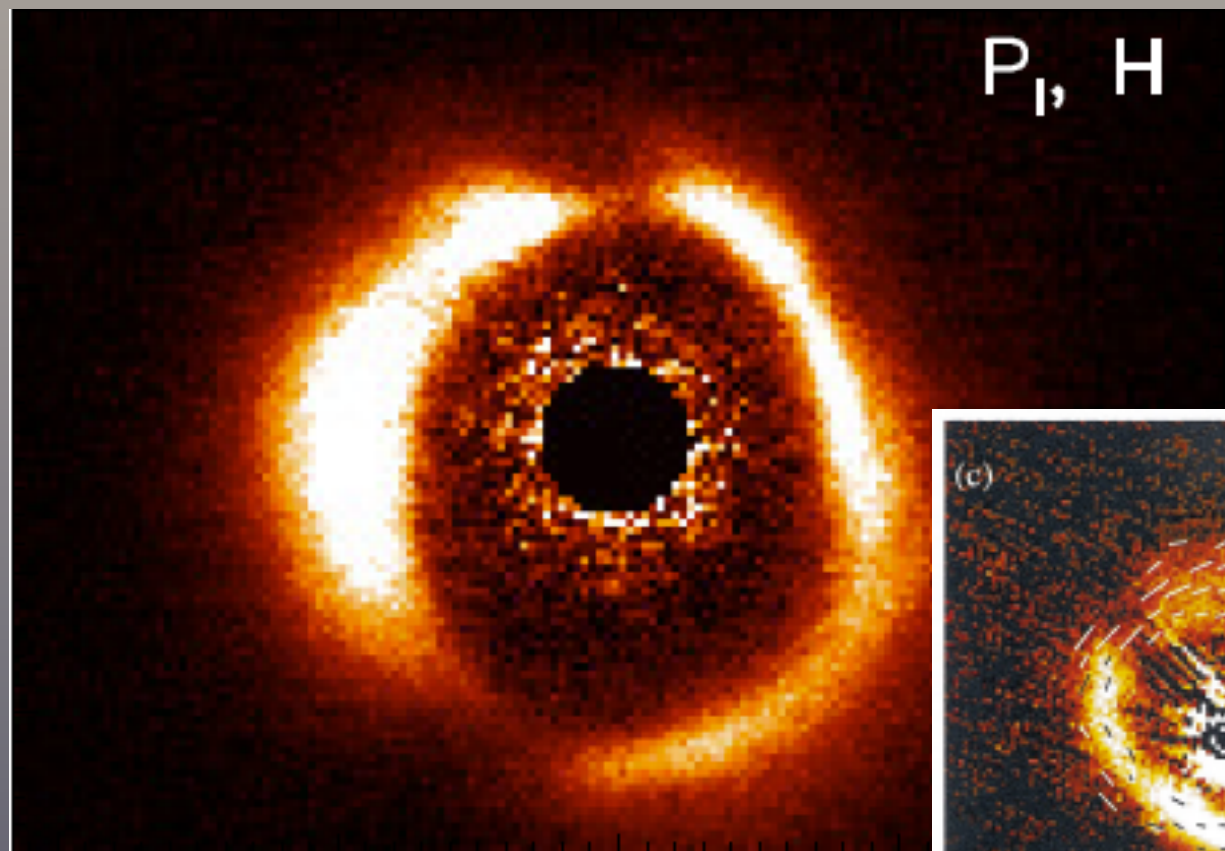

Hunting the Polarization Degree

$$P = P_I / I$$

$$P_{\Theta} = 0.5 \cdot \arctan\left(\frac{U}{Q}\right)$$

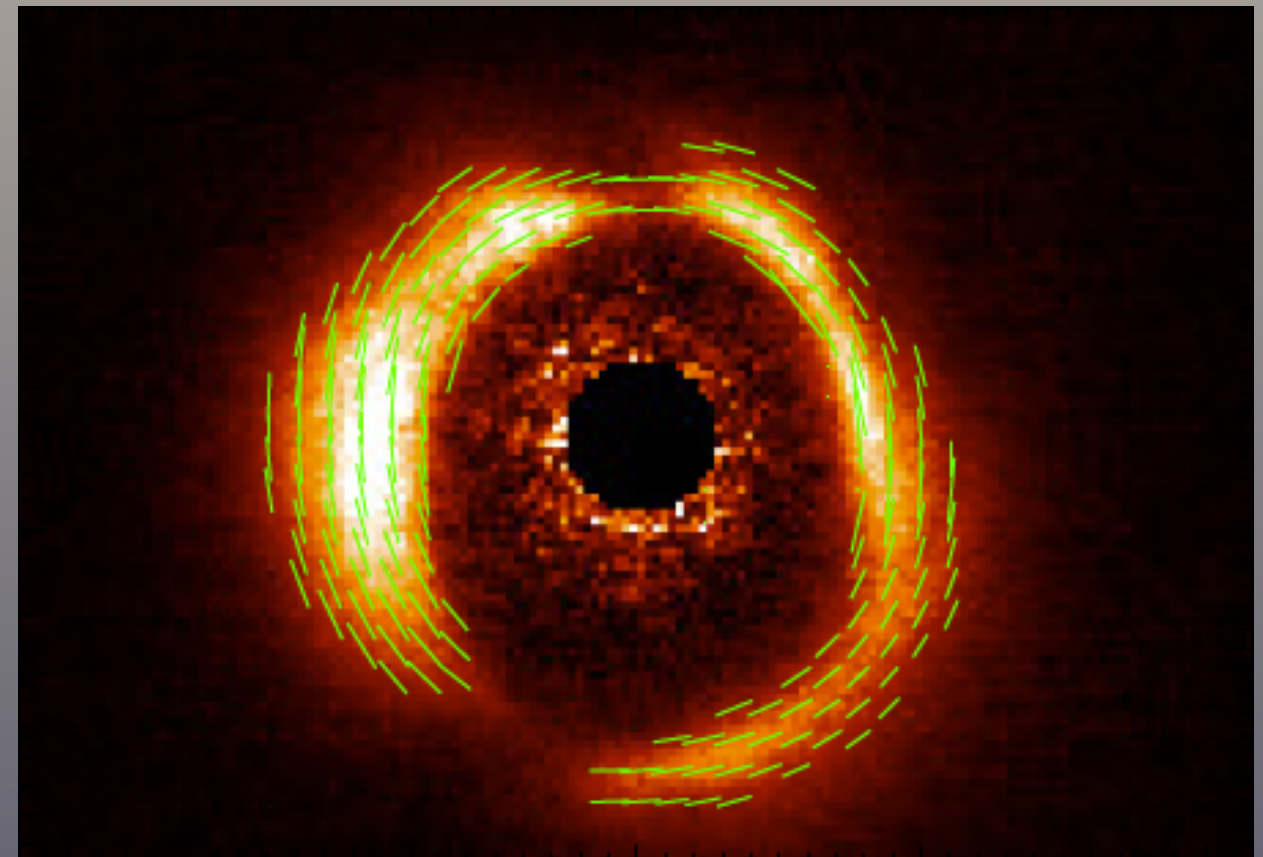
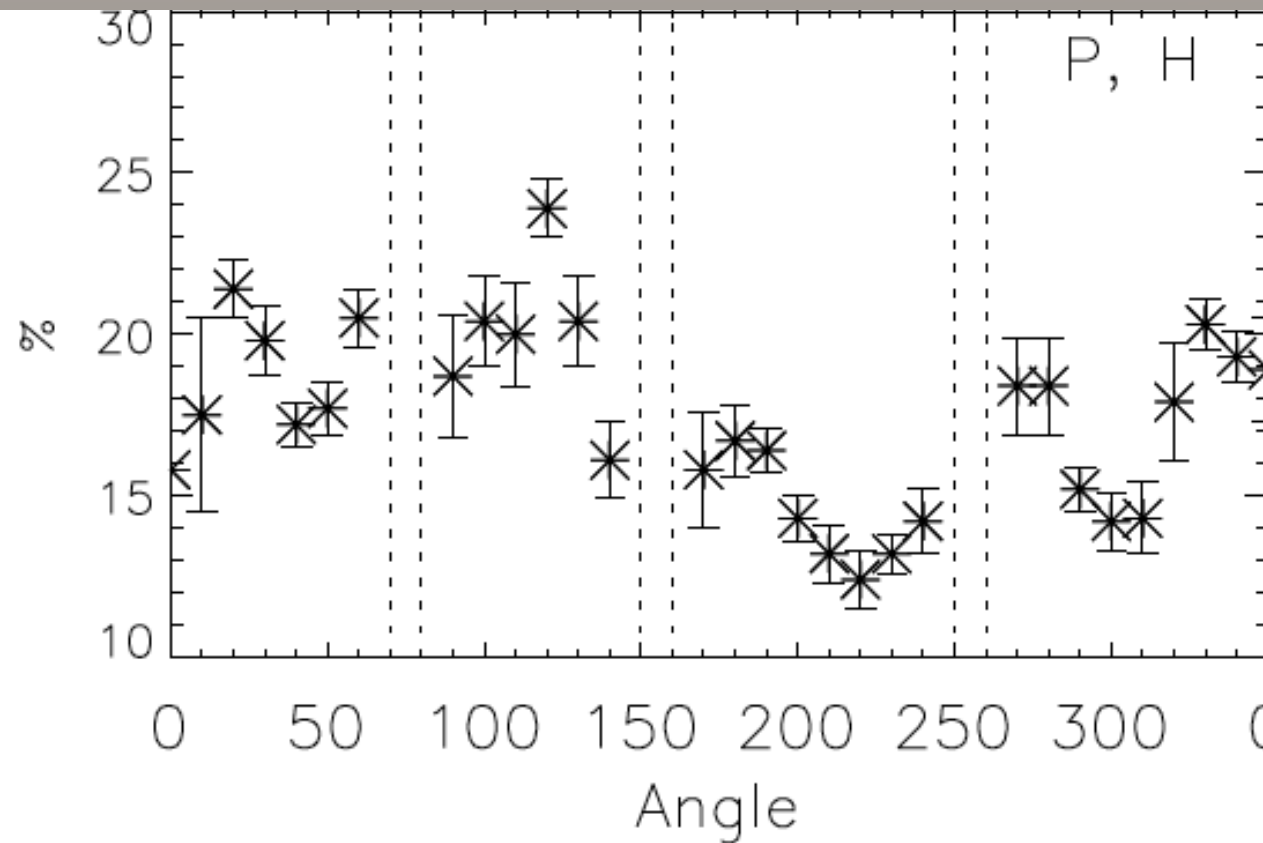



Imaging P

Nice Images

Hunt

tion Degree

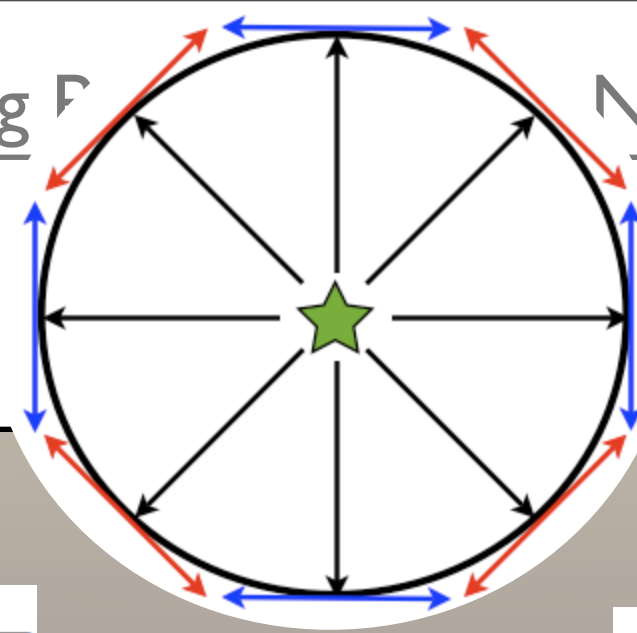

$$P = P_I / I$$

$$P_{\Theta} = 0.5 \cdot \arctan\left(\frac{U}{Q}\right)$$

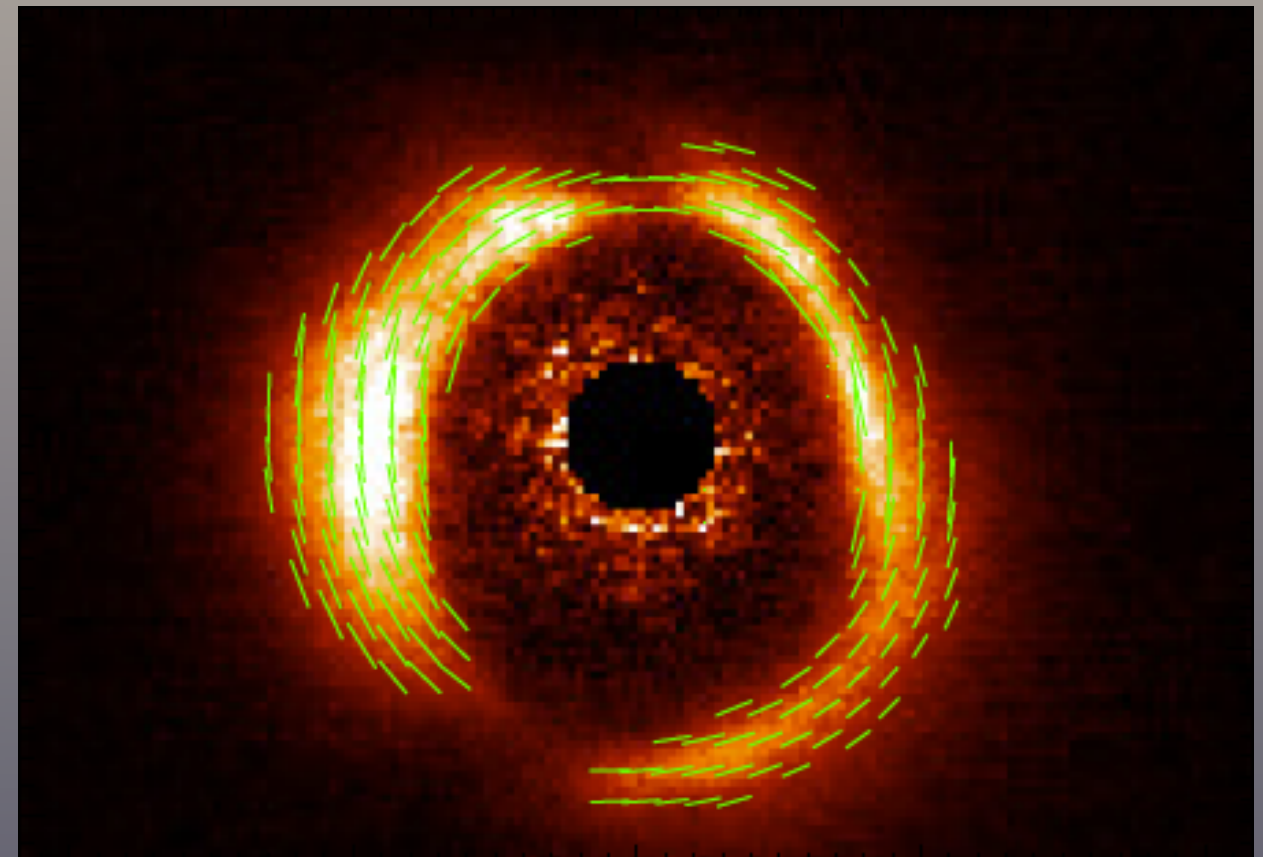
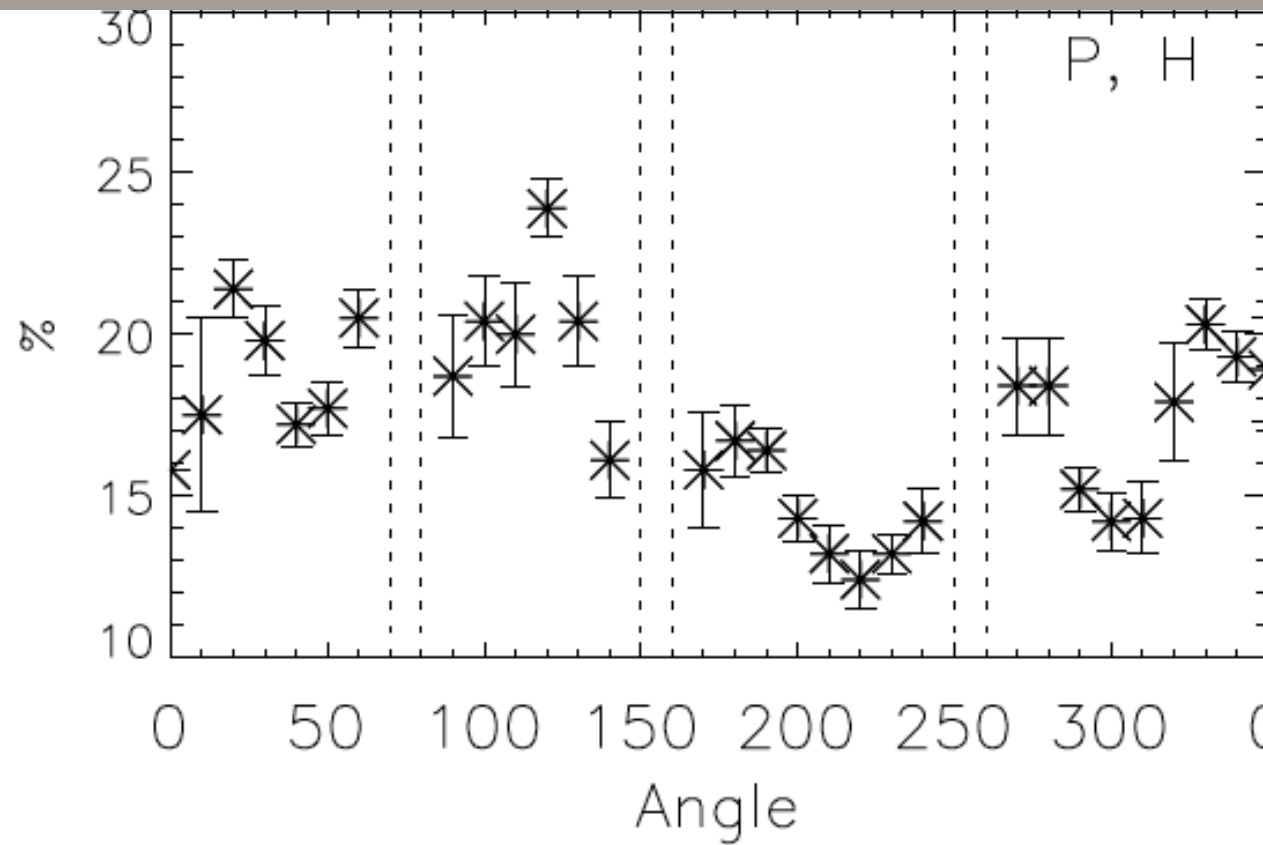



Imaging P

Nice Images

Hunt

tion Degree

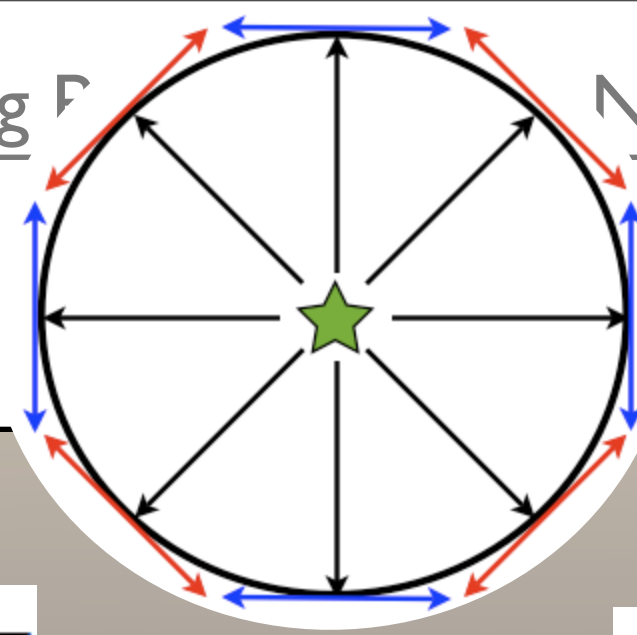

$$P = P_I / I$$

$$P_{\Theta} = 0.5 \cdot \arctan\left(\frac{U}{Q}\right)$$

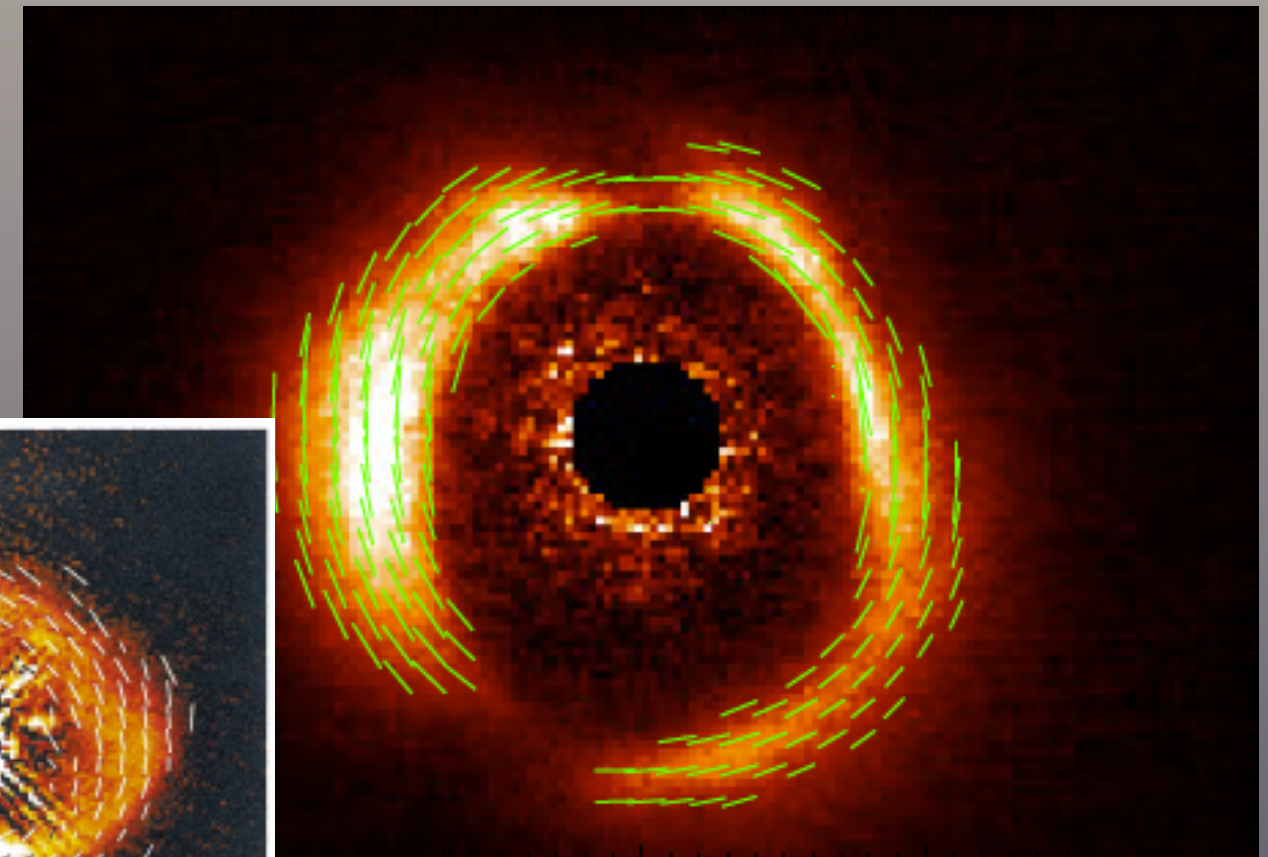
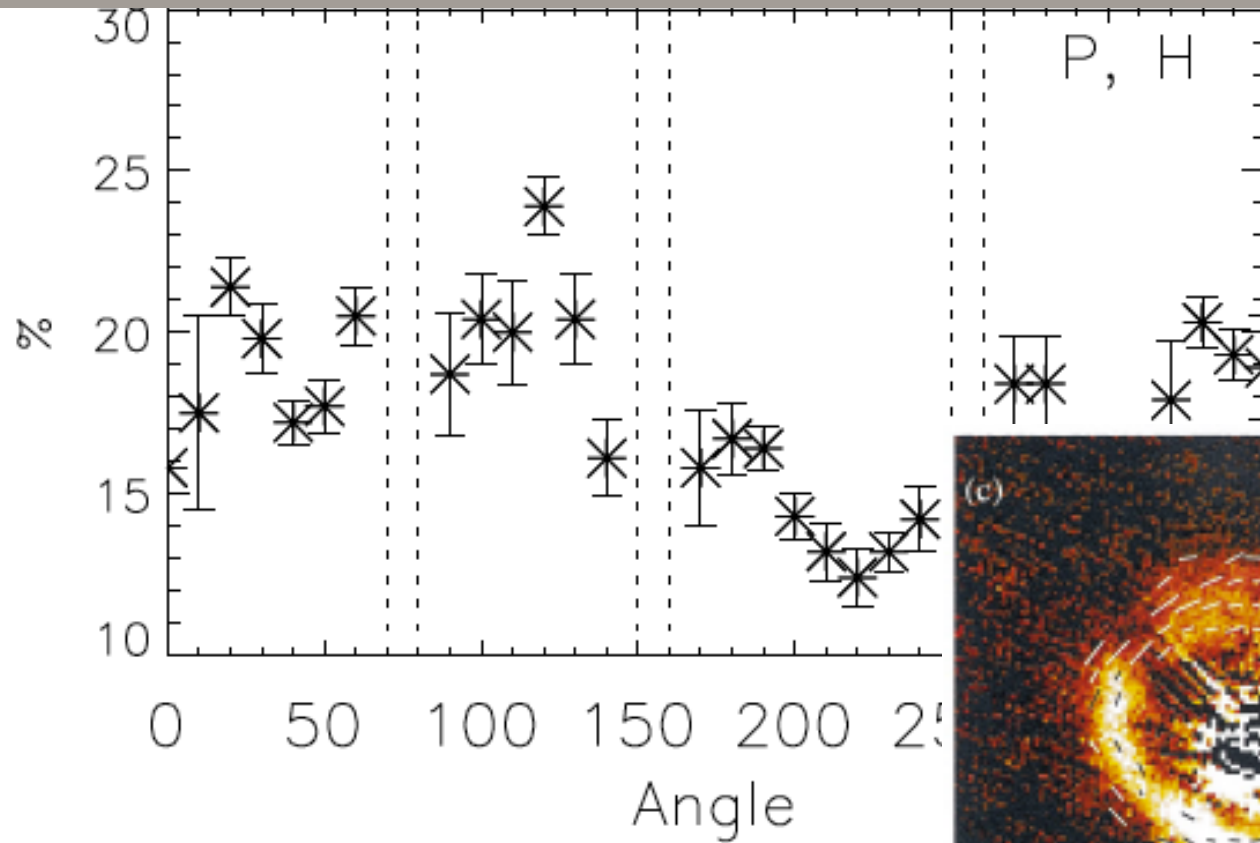



HiCIAO (Subaru): my (your??) personal enemy...

PDS 70

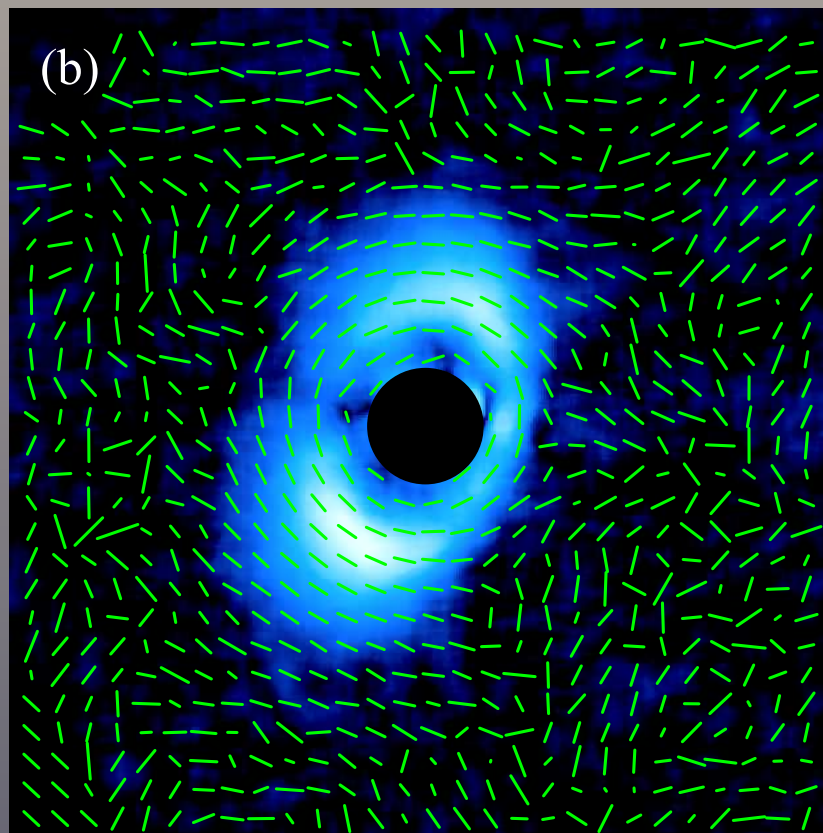

UX Tau X

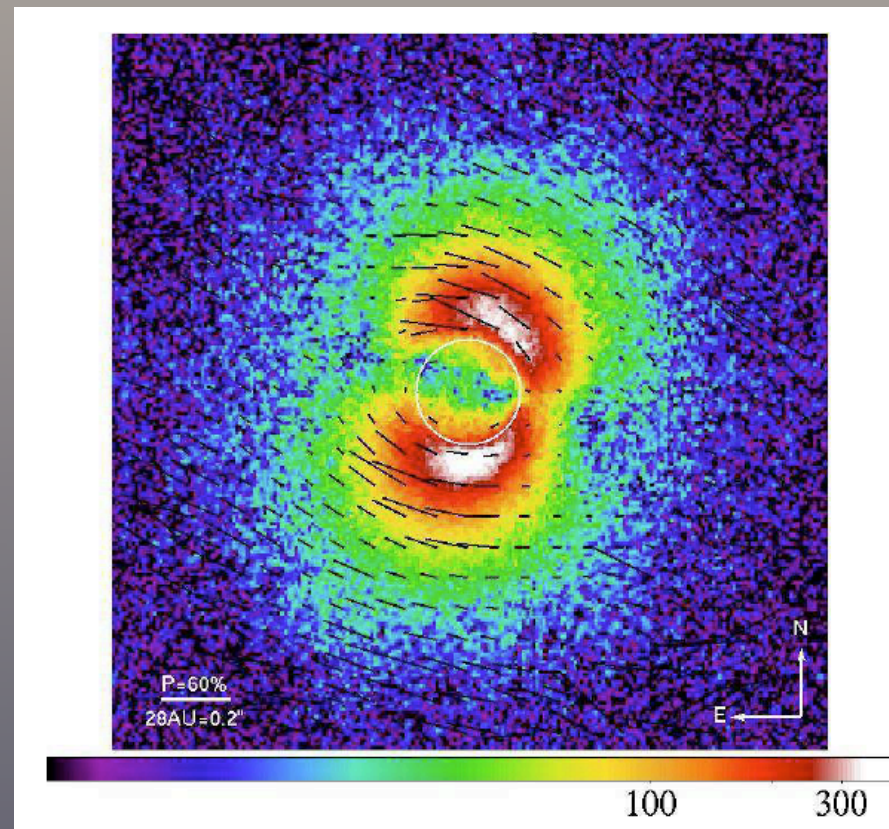

MWC 480

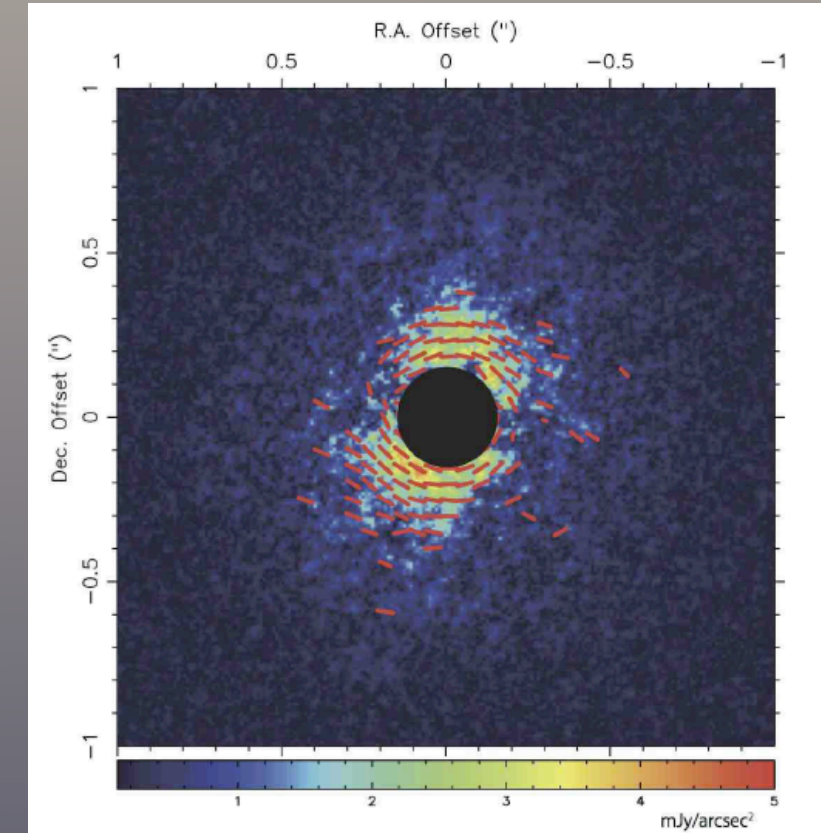



HiCIAO (Subaru): my (your??) personal enemy...



PDS 70

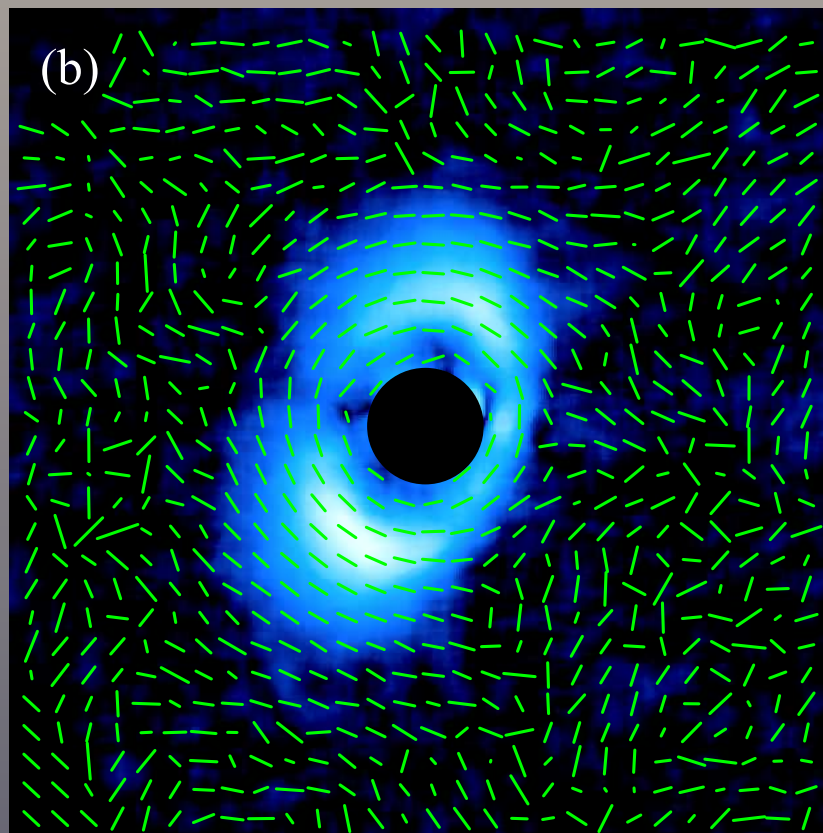

UX Tau X

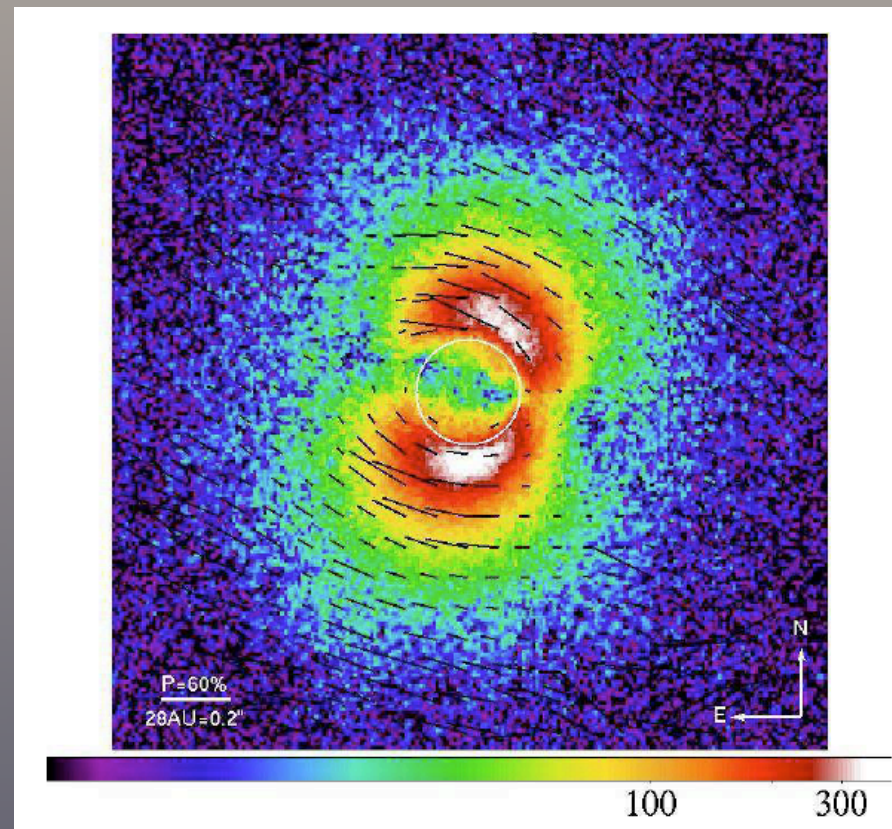

MWC 480

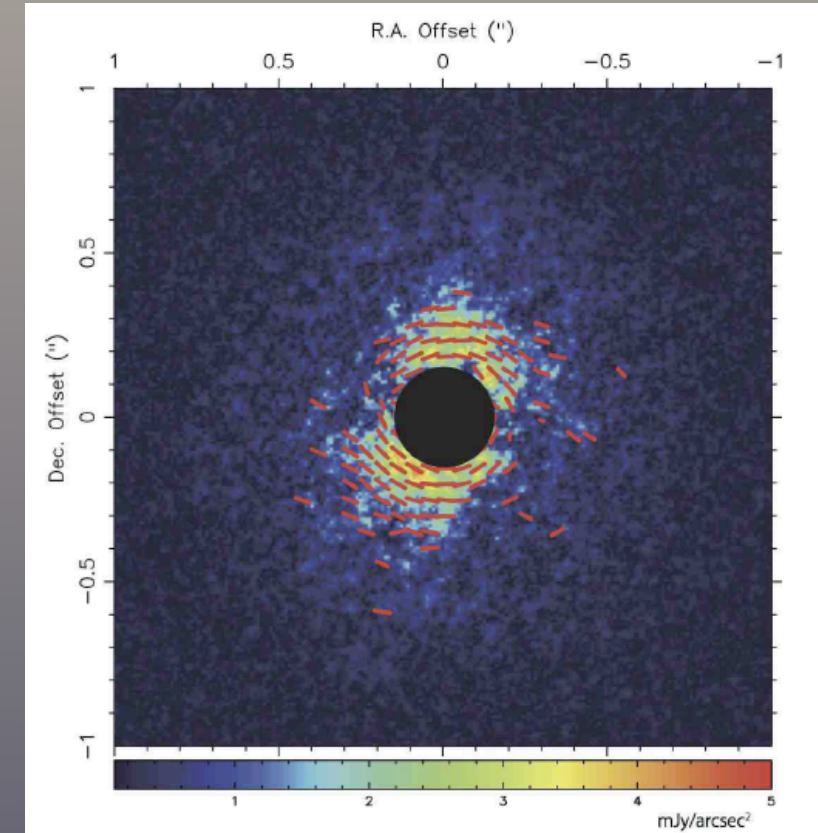



Future Imaging Polarimeters are
coming to Chile...

SPHERE @ VLT

GPI @ Gemini S





Future Imaging Polarimeters are coming to Chile...

SPHERE @ VLT

GPI @ Gemini S

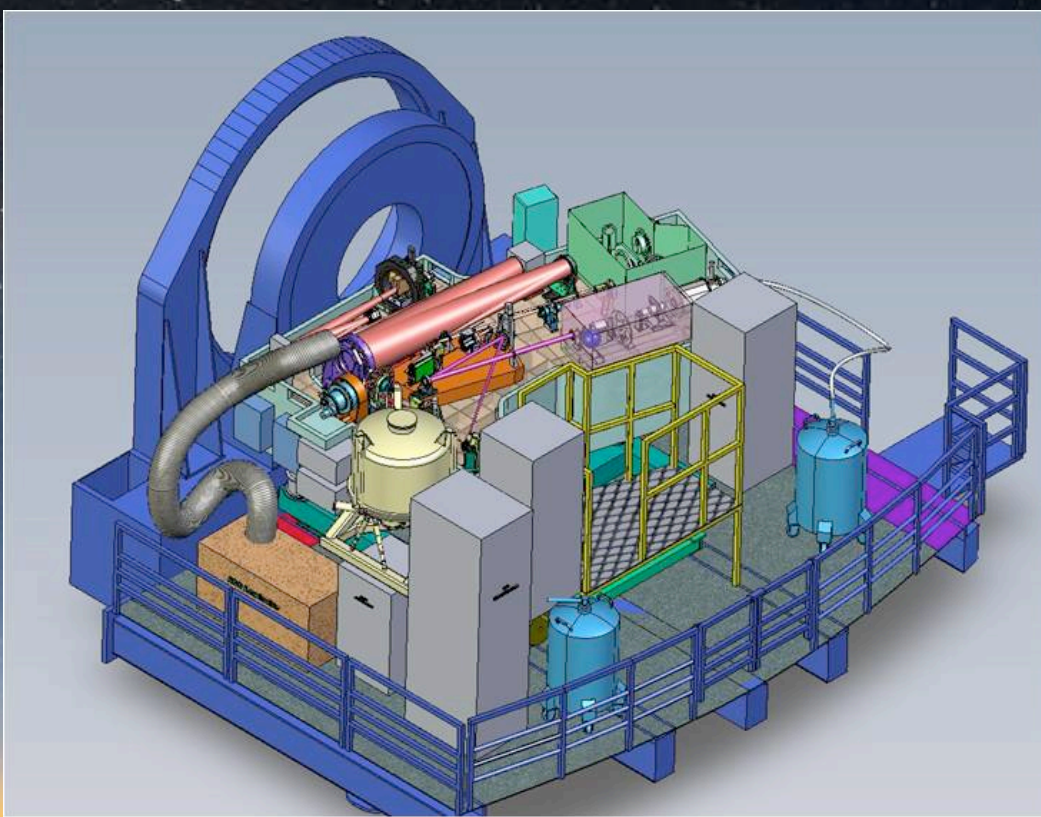



Future Imaging Polarimeters are coming to Chile...

SPHERE @ VLT

GPI @ Gemini S

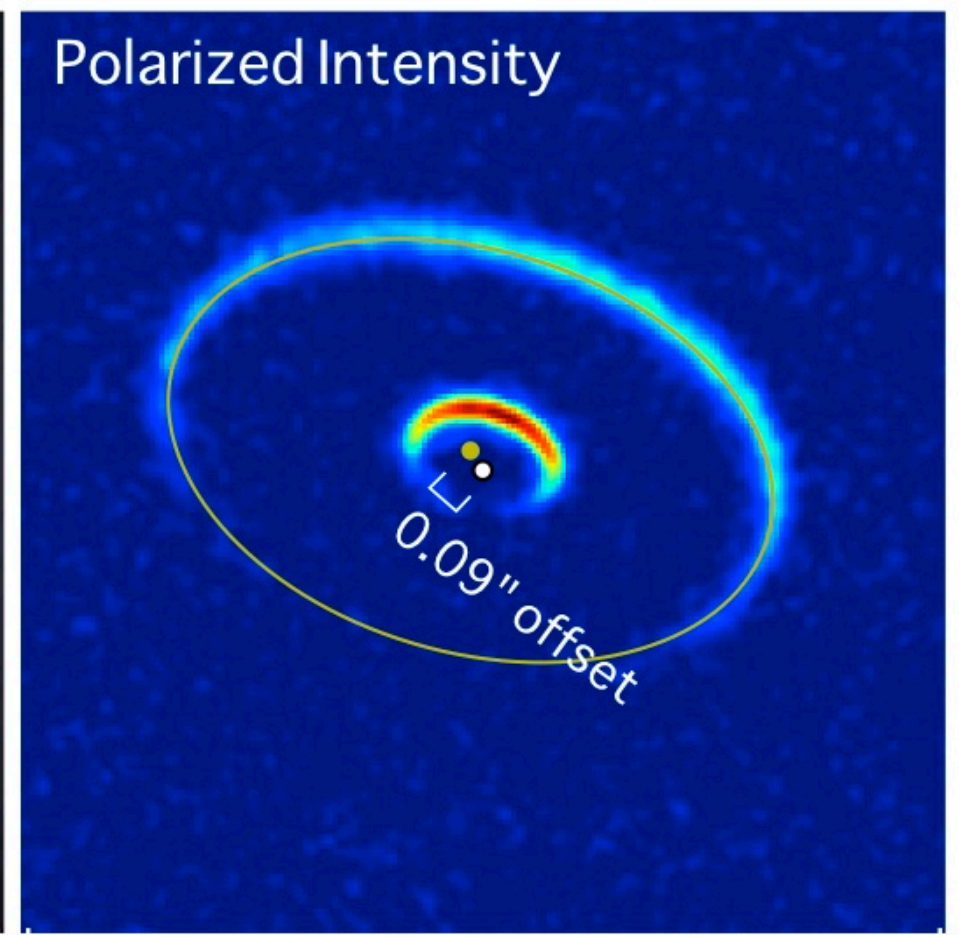
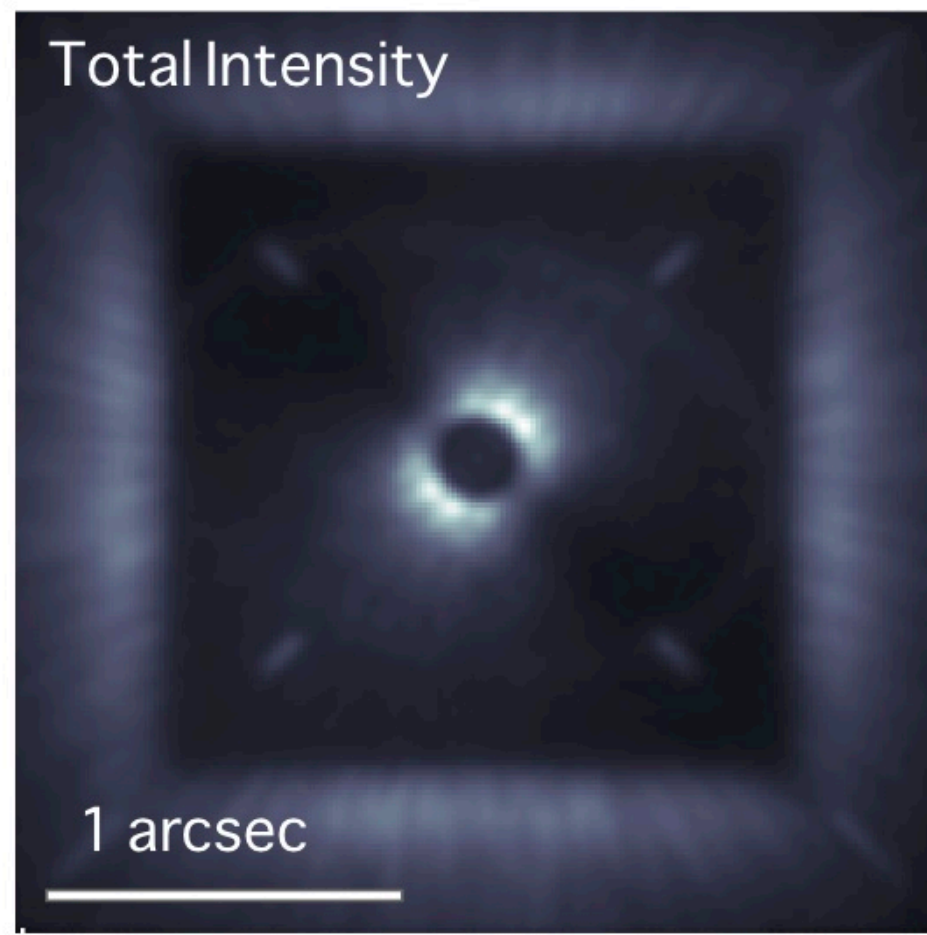
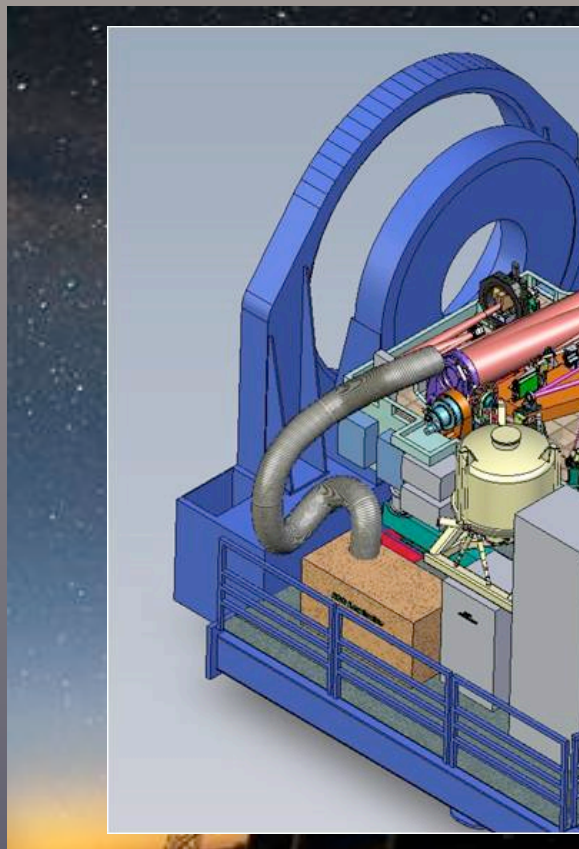



Imaging Polarimetry: PRESENT & FUTURE

